

# QST

devoted entirely to

# amateur radio

July  
1933  
25 cents



# THE RADIO AMATEUR'S LICENSE MANUAL

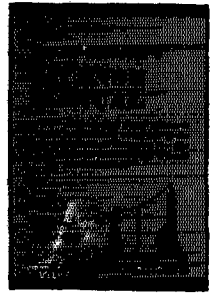

Tells you in much detail how to go about the business of obtaining your amateur license. It contains a questions and answers section which covers every type of question asked in the examination, for temporary, 1st class or extra-first license. Special section on examination for unlimited phone license.

28 pages, QST size, two color paper cover

**PRICE: 25 CENTS, POSTPAID**  
(No Stamps, Please)

**AMERICAN RADIO  
RELAY LEAGUE**

West Hartford  
Connecticut  
U. S. A.

West Hartford  
Connecticut  
U. S. A.

**AMERICAN RADIO  
RELAY LEAGUE**

**PRICE: 50 CENTS, POSTPAID**

(No Stamps, Please)

80 pages, QST size, two color paper cover

The recipe book of amateur radio. Did it ever occur to you that —  
“a rectangular aluminum pan would make a good solid chassis for  
a receiver and save the trouble of cutting and assembling a  
sub-panel and braces”? This is typical of the thousands  
of good ideas from hundreds of good amateurs  
contained in this new A.R.R.L. book.

**HINTS  
& KINKS  
for the RADIO AMATEUR**

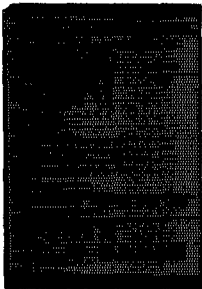

★ **NEW SIZES!**

★ **NEW PRICES!**

*Now — more than ever*

## **CARDWELL IS YOUR BEST BET**

New and lower list prices are now in effect on many popular sizes of **CARDWELL** receiving and transmitting condensers.

The 16-B transmitting condenser, particularly, intermediate size between the long famous "standard" model and the 166-B high voltage condenser, has been reduced in price, and considering the unsurpassed quality and sturdiness of this fine instrument, the 16-B is now a *real buy*. No finer condenser is built unless it's another **CARDWELL**!

Price reductions extend also to the 166-B high voltage models.

No reason now to limp along with *less than* **CARDWELL** quality —

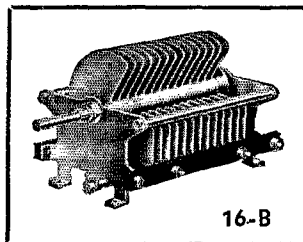

"FEATHERWEIGHT"

**CARDWELL MIDWAY "FEATHERWEIGHT" CONDENSERS, RECEIVING and TRANSMITTING  
CARDWELL "STANDARD" MODELS FOR RECEIVERS and  
MEDIUM POWERED TRANSMITTERS**

**CARDWELL 16-B TRANSMITTING CONDENSERS FOR LARGER TRANSMITTERS**

**CARDWELL HIGH VOLTAGE CONDENSERS FOR COMMERCIAL RADIO-TELEGRAPH  
and BROADCASTING STATIONS**

**CARDWELL S-2244 OIL DIELECTRIC FIXED CONDENSERS FOR HIGH FREQUENCY  
FURNACES and TUBE BOMBARDERS**

**THERE'S A CARDWELL FOR EVERY TUBE, PURPOSE and POCKETBOOK**

*Send for literature*

### **THE ALLEN D. CARDWELL MFG. CORP'N.**

**83 PROSPECT STREET, BROOKLYN, N. Y.**

*Any reliable supplier should cooperate with you to enable you to get what you want. He can get **CARDWELLS** for you if he does not keep them in stock. Get what you want—insist on **CARDWELLS**. Order direct from us if your dealer will not supply you, or let us tell you where you may buy.*

**"THE STANDARD OF COMPARISON"**

# NEW Westinghouse INSTRUMENTS

*meet*  
**ALL RADIO**  
*Requirements*

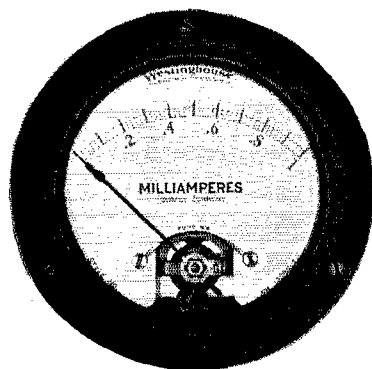

—at prices to fit your pocketbook

**O**F special interest to the amateur and experimenter is the complete new line of Westinghouse types MX and NX small-size, panel-mounting radio instruments.

Included in this line are ratings to meet every need of the amateur and commercial radio engineer. Rectifier volt-meters with resistances from 1000 up to 10,000 ohms per volt are standard. Rectifier milliammeters and micro-ammeters are included, as well as radio-frequency ammeters and milliammeters in all ranges.

New ideas in improved design and construction are used. Permanent magnets of high grade tungsten or cobalt steel are welded to the soft iron pole pieces in accurately



**WESTINGHOUSE**  
**ELECTRIC & MANUFACTURING COMPANY**  
ROOM 2-N . . . EAST PITTSBURGH, PA.

aligned fixtures, resulting in permanent accuracy and uniform scale spacing.

The iron core, movement, and jeweled bearings are supported by a single die-cast frame for easy removal of the moving element as a unit.

The matte silvered dials are made of metal to prevent warping.

## SEND FOR CATALOG

Write for Catalog 43-340 describing and listing the type MX and NX instruments, which will be sent to you without charge.

Although MX and NX instruments have many new improvements, they are sold at extremely reasonable prices. See your local dealer for full information. If he cannot supply you, drop a post card to— T 79595

# QST

Published monthly, as its official organ, by the American Radio Relay League, Inc., at West Hartford, Conn., U. S. A.; Official Organ of the International Amateur Radio Union

devoted entirely to

# AMATEUR RADIO

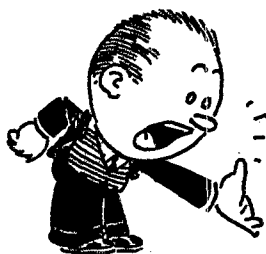

Editorials . . . . .	7
World's Fair A.R.R.L. Convention . . . . .	8
Who Received the Message? . . . . .	8
OA4U — On the Roof of the World . . . . . S. L. Seaton	9
The Micrometer Frequency Meter . . . . . G. F. Lampkin, W8ALK	10
An Unusual 56-Mc. Super-Regenerative Receiver . . . . . J. G. Haydock, Jr., W3ACD	14
More DX on 56 Mc. . . . .	16
Kansas National Guard Station CX7 . . . . .	16
Twisted-Pair Feeders for the Transmitting Antenna . . . . . George Grammer	17
Financial Statement . . . . .	20
A Simple Tape Recorder for C. W. . . . .	21
Recording Signals with the Teleplex . . . . .	22
Annual Meeting of the Board of Directors . . . . . K. B. Warner	23
Standard Frequency Schedules . . . . .	25
A Shack on Wheels . . . . . Philip S. Rand, W1DBM-W1FWL	26
Economical Use of a Milliammeter . . . . . William G. Pierpont, W9BLK-HPU	28
The Governors' President Relay . . . . .	30
A Flea-Powered Portable Phone with Crystal Control . . . . . G. W. Fox, R. J. Pieracci and W. L. Huebner	32
Match Your Impedances . . . . . Daniel E. Noble	34
Announcement — AI Operator's Club . . . . .	36
Strays . . . . .	37
Club Directory Available . . . . .	37
Tube Checker Correction . . . . .	37
For the Experimenter . . . . .	
83's IN HIGH VOLTAGE RECTIFIERS — A DIFFERENT KEYING TUBE CIRCUIT — A JUNK BOX VOLTAGE REGULATOR FOR THE M. G. — HOME-MADE OVERLOAD RELAY . . . . .	38
Amateur Radio Stations . . . . . NYIAA, W8CPY	41
Calls Heard . . . . .	43
The Iowa-Midwest Division Convention (Report) . . . . .	43
Communications Department . . . . .	44
I. A. R. U. News . . . . .	59
Correspondence Department . . . . .	62
Extending Freqmeter Calibration . . . . .	74
Hamads and QRAs . . . . .	75
QST's Index of Advertisers . . . . .	78

JULY  
1933

VOLUME XVII  
NUMBER 7

Kenneth B. Warner (Secretary, A.R.R.L.), Editor-in-Chief and Business Manager; Ross A. Hull, Associate Editor; James J. Lamb, Technical Editor; George Grammer, Assistant Technical Editor; Clark C. Rodimon, Managing Editor; David H. Houghton, Circulation Manager; F. Cheyney Beekley, Advertising Manager; Ursula M. Chamberlain, Assistant Advertising Manager.

Editorial and Advertising Offices  
38 La Salle Road, West Hartford, Conn.

Subscription rate in United States and Possessions and Canada, \$2.50 per year, postpaid; all other countries, \$3.00 per year, postpaid. Single copies, 25 cents. Foreign remittances should be by international postal or express money order or bank draft negotiable in the U. S. and for an equivalent amount in U. S. funds.

Entered as second-class matter May 29, 1919, at the post office at Hartford, Connecticut, under the Act of March 3, 1879. Acceptance for mailing at special rate of postage provided for in section 1103, Act of October 3, 1917, authorized September 9, 1922. Additional entry at Concord, N. H., authorized February 21, 1929, under the Act of February 28, 1925.

Copyright 1933 by the American Radio Relay League, Inc.  
Title registered at United States Patent Office.

# New

**H**AMMARLUND isn't always first to make "improvements"—but they quickly take first place when they are made.

That is the way with all really fine things—it takes time to be *RIGHT*.

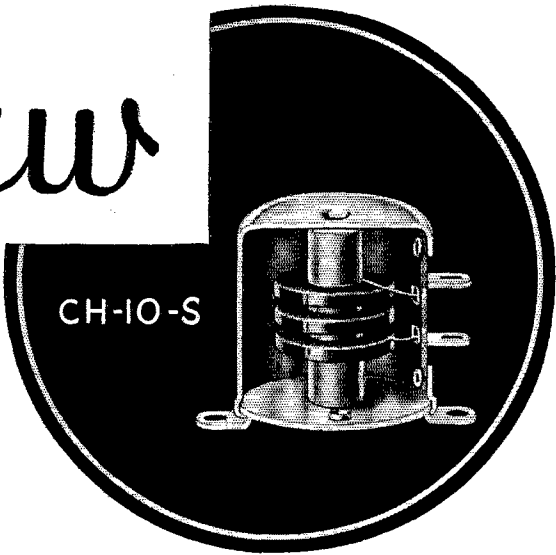

CH-10-S

- **CH-10-S**—Improved R.F. Choke for high-gain circuits. Completely shielded in aluminum shell. Minimum external field. Permits compact receiver without stray coupling or feedback.  $1\frac{1}{2}$ " high x  $1\frac{3}{8}$ " wide. Inductance 10 mh.; D.C. resistance 65 ohms; current capacity 100 milliamperes.
- **CH-8**—Compact, low loss R.F. Choke for short and ultra short-wave receivers and transmitters. Equally efficient on broadcast band.  $1\frac{3}{8}$ " x  $\frac{7}{8}$ ". Inductance 8 mh.; D.C. resistance 70 ohms; current capacity 125 milliamperes.
- **CH-500**—Heavy duty Transmitting Choke.  $2\frac{3}{8}$ " x  $1\frac{5}{16}$ ". Inductance 5.3 mh.; D.C. resistance 12 ohms; current capacity 500 milliamperes.
- **ATT-175 and 465 kc.**—I.F. Transformers with air-dielectric tuning condensers and Litz coils on Isolantite form.  $2\frac{3}{32}$ " x 5". Oscillator (ATO-465) has tuning lever to vary beat note.
- **MC-35-X and MC-50-X**—Double-Spaced Midget Condensers, for ultra S-W receivers and transmitters. Special bearings. Isolantite insulation. Air gap between plates .0715".
- **MC**—Standard Midget Condenser. Soldered brass plates. Isolantite insulation. 11 sizes, 20 to 320 mmf. maximum capacity. "Midline" and Straight Line types.
- **MCD-35-X**—Double-Spaced Dual Midget Condenser. Special bearings. Isolantite insulation. Capacity per section 33 mmf. maximum.

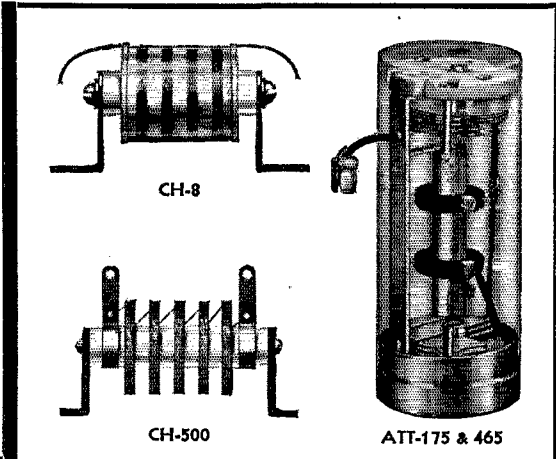

CH-8

CH-500

ATT-175 & 465

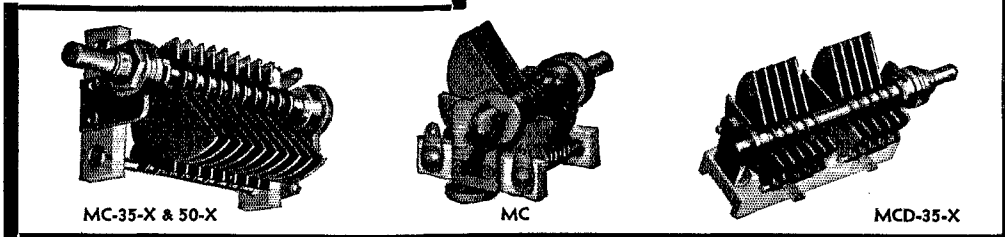

MC-35-X & 50-X

MC

MCD-35-X

HAMMARLUND MANUFACTURING CO.  
424 W. 33rd St., New York

— Check here for new booklet describing COMET "PRO" Short-Wave Superheterodyne Receiver. — Check here for General Catalog.

Name .....

Address .....

.....Q-7



## Section Communications Managers of THE COMMUNICATIONS DEPARTMENT, A. R. R. L.

Eastern Pennsylvania Maryland-Delaware-District of Columbia Southern New Jersey Western New York Western Pennsylvania	W3GS W3NY W3QL W8OSP W8CUG	<b>ATLANTIC DIVISION</b> Jack Wagenseller  Harry Ginsberg Gedney Rigor Don Farrar C. H. Grossarth	210 Main St.  2305 N. Pulaski St. 412 2nd Ave. 213 Hickox Ave. R. F. D. 3, Elcher Rd.	Pennsburg  Baltimore, Md. Haddon Heights Syracuse Emsworth, Bellevue, Pa.
Illinois Indiana Kentucky Michigan Ohio Wisconsin	W9WR W9TE W9DX W8DVH W8BAH W9FSS	<b>CENTRAL DIVISION</b> Fred J. Hinds Arthur L. Braun Carl L. Phum Kenneth F. Conroy Harry A. Tummonds Harold H. Kurth	6618 West 34th St. 1321 Spruce St. P. O. Box 359 7553 E. Robinwood Ave. 2073 West 85th St. 2550 N. 8th St.	Berwyn Indianapolis Louisville Detroit Cleveland Milwaukee
North Dakota South Dakota Northern Minnesota Southern Minnesota	W9DGS-IFW W9DEI W9DOQ W9EFJ	<b>DAKOTA DIVISION</b> Wm. Langer C. B. Miller Palmer Andersen Norman Beck	313 First Ave., S. 449 N. 5th St. Route 1, Box 270 415 Grand St.	Jamestown Redfield Duluth Winona
Arkansas Louisiana Mississippi Tennessee	W5ARI W5WF W5AZV W4AFM	<b>DELTA DIVISION</b> H. E. Velte W. J. Weinson, Jr. William G. Bodker F. F. Purdy	2918 West 15th St. 1624 Allen Ave. 1013 Bratton St. P. O. Box 173	Little Rock Shreveport Jackson Kingsport
Eastern New York N. Y. C. & Long Island Northern New Jersey	W2LU W2AZV W2CO	<b>HUDSON DIVISION</b> Robert E. Laight E. L. Bauach Walter A. Cobb	1080 Helderberg Ave. 7823 10th Ave. 28 Ampere Parkway	Schenectady Brooklyn East Orange
Iowa Kansas Missouri Nebraska	W9RFD W9FLG W9EVG-HCP W9FAM	<b>MIDWEST DIVISION</b> George D. Hansen O. Spetter C. R. Cannady Samuel C. Wallace	Box 27 305 Western Ave. 210 W. McCarty Green St.	Salix Topeka Jefferson City Clarke
Connecticut Maine Eastern Massachusetts Western Massachusetts New Hampshire Rhode Island Vermont	W1CTI W1GDY W1ASI W1ASY-W1RB W1ATJ W1AFO W1BD	<b>NEW ENGLAND DIVISION</b> Frederick Ellis, Jr. John W. Singleton Isabel A. Mullen Earl G. Hewinson V. W. Hodge Stanley Atkinson Roy Gale	19 Merrill Rd. 10 High Street 16 Mercer St. 33 Cortland St. 8 Sullivan St. 186 Magnolia St. 41 Beacon St.	Norwalk Wilton Springfield Claremont Auburn Barre
Alaska Idaho Montana Oregon Washington	K7PQ W7AVH W7AAT-7QT W7ABZ W7AYO	<b>NORTHWESTERN DIVISION</b> Richard J. Fox Charles R. Thrapp O. W. Viers Raymond W. Cummins Stanley J. Belliveau	Box 301 1011 East Jefferson St.  4835 N. Amherst St. Route 7, Box 387	Ketchikan Boise Red Lodge Portland Yakima
Hawaii Nevada Los Angeles Santa Clara Valley East Bay San Francisco Sacramento Valley Arizona Philippines* San Diego San Joaquin Valley	K6COG W6EAD W6AAN W6AMM W6ZM W6CAL W6DVE W6BJF-W6QC KALXA W6BOP W6DZN	<b>PACIFIC DIVISION</b> C. D. Slaten Keston L. Ramsay Francis C. Martin Bruce Stone S. C. Gouston Byron Goodman Geo. L. Woodington Ernest Mendoza Newton E. Thompson Harry A. Ambler G. H. Lavender	Pearl City 1151 Buena Vista Ave. 738 W. Huntington Drive R. 1, Box 311 2523 23rd Ave. 141 Alton Ave. 716 Redwood Ave. 1434 East Madison St. 6714 Tennessee 4101 Hamilton St. R. 0, Box 425	Oahu Reno Arcadia San Jose Oakland San Francisco North Sacramento Phoenix Manila, P. I. San Diego Stockton
North Carolina Virginia West Virginia	W4AVT W3AAJ W8HD	<b>ROANOKE DIVISION</b> G. H. Wright, Jr. R. N. Eubank C. S. Hofmann, Jr.	2817 Montrose Ave. 126 Washington Ave.	Wendell Richmond Wheeling
Colorado Utah-Wyoming	W9BTO W6DPJ	<b>ROCKY MOUNTAIN DIVISION</b> T. R. Becker C. R. Miller	1176 Gaylord St. 134 E. 2nd North St.	Denver Provo, Utah
Alabama Eastern Florida Western Florida Georgia-So. Carolina-Cuba- Isle-of-Pines-Porto Rico- Virgin Islands	W4KP W4NN W4MS  W4PM	<b>SOUTHEASTERN DIVISION</b> L. D. Elwell Ray Atkinson Edward J. Collins  Chas. W. Davis	1066 Waverly St. 329 East First St. 1517 East Brainard St.  91 North Ave., N.W.	Tarrant Jacksonville Pensacola  Atlanta
Northern Texas Oklahoma Southern Texas New Mexico	W5AUL W5VQ W5BHO W5AUV	<b>WEST GULF DIVISION</b> Glen E. Talbutt Emil Gisel David H. Calk Jerry Quinn	1902 South 11th St. 1st Balloon Co. 6726 Ave. Q 524 West Coal Ave.	Abilene Fort Sill Houston Albuquerque
Maritime	VE1DQ	<b>MARITIME DIVISION</b> A. M. Crowell	69 Dublin St.	Halifax, N. S.
Ontario	VE3HB	<b>ONTARIO DIVISION</b> H. W. Bishop	258 Egerton St.	London
Quebec*	VE2AP	<b>QUEBEC DIVISION</b> J. C. Stadler	4334 Westmount Ave.	Westmount, P. Q.
Alberta British Columbia	VE4HM VE5AL	<b>VANALTA DIVISION</b> C. H. Harris J. K. Cavalsky	10806 125th St. 4868 Blenheim St.	Edmonton Vancouver
Manitoba Saskatchewan	VE4GC VE4EL	<b>PRAIRIE DIVISION</b> Reg. Strong Wilfred Skaife	284 Marlon St. 2040 McTavish St.	Winnipeg Regina

\* Officials appointed to act until the membership of the Section choose permanent SCM's by nomination and election.

# The American Radio Relay League



• **T**HE AMERICAN RADIO

RELAY LEAGUE, Inc., is a non-commercial association of radio amateurs, bonded for the promotion of interest in amateur radio communication and experimentation, for the relaying of messages by radio, for the advancement of the radio art and of the public welfare, for the representation of the radio amateur in legislative matters, and for the maintenance of fraternalism and a high standard of conduct.

It is an incorporated association without capital stock, chartered under the laws of Connecticut. Its affairs are governed by a Board of Directors, elected every two years by the general membership. The officers are elected or appointed by the Directors. The League is non-commercial and no one commercially engaged in the manufacture, sale or rental of radio apparatus is eligible to membership on its board.

"Of, by and for the amateur," it numbers within its ranks practically every worth-while amateur in the world and has a history of glorious achievement as the standard-bearer in amateur affairs.

Inquiries regarding membership are solicited. A bona fide interest in amateur radio is the only essential qualification; ownership of a transmitting station and knowledge of the code are not prerequisite. Correspondence should be addressed to the Secretary.

## DIRECTORS

<i>President</i>	
HIRAM PERCY MAXIM.....	W1AW Box 216, Hartford, Conn.
<i>Vice-President</i>	
CHARLES H. STEWART.....	W3ZS St. David's, Pa.
<i>Canadian General Manager</i>	
ALEX. REID.....	VE2BE 169 Logan Ave., St. Lambert, P. Q.
<i>Atlantic Division</i>	
EUGENE C. WOODRUFF.....	W8CMP 234 W. Fairmount Ave., State College, Pa.
<i>Central Division</i>	
LOREN G. WINDOM.....	W8GZ-W8ZG 1375 Franklin Ave., Columbus, Ohio
<i>Dakota Division</i>	
LAWRENCE E. LINDESMITH.....	W9GKO 1055-85th Ave. W., Duluth, Minn.
<i>Delta Division</i>	
M. M. HILL.....	W5EB P.O. Box 274, Natchitoches, La.
<i>Hudson Division</i>	
BERNARD J. FULD.....	W2BEG 280 Broadway, New York City
<i>Midwest Division</i>	
H. W. KERR.....	W9DZW-W9GP Little Sioux, Iowa
<i>New England Division</i>	
G. W. BAILEY.....	W1KH 74 Webster Road, Weston, Mass.
<i>Northwestern Division</i>	
RALPH J. GIBBONS.....	W7KV-W7BIX 35 Park St., Walla Walla, Wash.
<i>Pacific Division</i>	
S. G. CULVER.....	W6AN 2303 Seventh Ave., Oakland, Calif.
<i>Ranoke Division</i>	
H. L. CAVENESS.....	W4DW State College Station, Raleigh, N. C.
<i>Rocky Mountain Division</i>	
RUSSELL T. ANDREWS.....	W9AAB 169 So. Ogden St., Denver, Colo.
<i>Southeastern Division</i>	
J. C. HAGLER, JR.....	W4SS 2424 McDowell St., Augusta, Ga.
<i>West Gulf Division</i>	
FRANK M. CORLETT.....	W5ZC 2515 Catherine St., Dallas, Tex.

## OFFICERS

<i>President</i> .....	HIRAM PERCY MAXIM, W1AW Hartford, Connecticut
<i>Vice-President</i> .....	CHARLES H. STEWART, W3ZS St. David's, Pennsylvania
<i>Secretary</i> .....	KENNETH B. WARNER, W1EH West Hartford, Connecticut
<i>Treasurer</i> .....	ARTHUR A. HEBERT, W1ES West Hartford, Connecticut
<i>Communications Mgr.</i> , F. EDWARD HANDY, W1BDI West Hartford, Connecticut	
<i>General Counsel</i> .....	PAUL M. SEGAL, W3EEA 1010 Shoreham Building, Washington, D. C.

Address all general correspondence to the executive headquarters at West Hartford, Connecticut



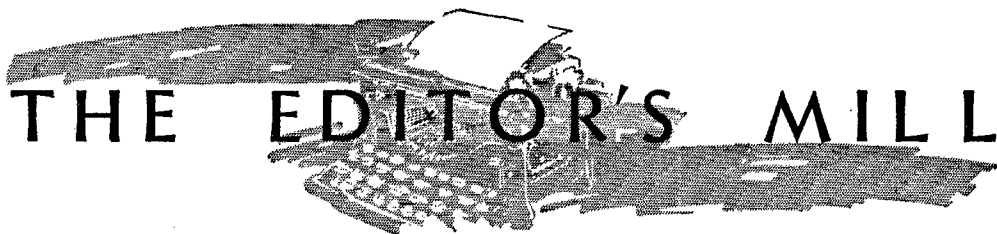

# THE EDITOR'S MILL

**I**T IS not too early to give a thought to the Cairo conference. We believe that the time is now ripe for us to move towards a job that we have long wanted to undertake, a much-warranted widening of some of our bands.

Since the Washington conference, the first international radio conclave since the advent of short waves, our job has been as much to keep a finger on the pulse of radio development and international sentiment as it has been the actual representation of the amateur. Things are changing. The atmosphere of the Washington conference was violently hostile towards the amateur. As we have become better known and our merits appreciated, we have grown in strength and recognition. By participation in all of the recent international conferences, amateur radio has achieved for itself the position of a service for which adequate provision must be made. Much as we wanted to plug for enlargement of our bands at Madrid, it was evident that the time had not yet arrived; nor, being only the second international conference since the exploitation of high frequencies commenced, could one have any reasonable idea of what outcome to expect; and we couldn't even sell our own government, the most liberal in the world, the notion of enlargement. Now the situation changes. There is a difference in the sentiment towards us, in our own numbers and strength, in the relative needs of other services. We now believe that we can look forward to this thing we have wanted so long, in particular an enlargement of our 40-meter band.

Heaven knows we need more room. There are 36,000 of us in this one country alone, perhaps 60,000 of us in the world. We are packed in like cord-wood while all around us there are vast open spaces in which almost nothing is to be heard. Partly, we suppose, the business depression may be responsible; but it is true that there was a stampede to the high frequencies akin to a gold rush and that allocations were staked out by different services out of all proportion to their actual needs. The last several years not only have shown this but have displayed that high-frequency operation is not all cakes and ale. A lot of this hysteria has disappeared and a much more realistic viewpoint prevails.

Our lower-frequency bands may be adequate. It's a pretty tough job to run a radio station in the 3500-4000 band these days but we are still

able to do it and we may be able to continue it if we don't experience too much additional growth. But our 7-megacycle band has an effective width less than a third as great, and simply because it is the world-wide meeting place for international communication between the amateurs of every country on the globe, it presents an intolerable condition, interference such as the radio art has never elsewhere seen.

Simple justice requires a correction of this condition, a readjustment that will give the amateur his just due. It is unfair that our valuable work should be so sorely handicapped when there is not pressing need for the frequencies assigned to other services near us. The time is at hand. We hereby serve notice on the radio world that the amateur 40-meter band must be adequately widened at Cairo.

**E**VERY amateur knows that there are a lot of rotten conditions in our bands. Whenever we get together we talk about them, cast about for remedies. We realize that things grow steadily worse, so that the enjoyment of every amateur is seriously threatened. Of course some of these are simply operating evils, of the sort that a cluck operator can create with a perfectly good signal. But by and large they are caused by bad signals. Did it even occur to you that practically every one of these burdensome interferences with legitimate amateur operation is in violation of radio regulations and that if we had any adequate enforcement of regulations in this country they would virtually disappear?

A moment's reflection and you will see that we are right. Raw a.c. on oscillators, wobulated signals, harmonics, broad modulated signals, intentional tone modulation, key clicks — all are strictly prohibited by the amateur regulations. The plain truth of the matter is that there is no radio enforcement in the amateur bands. For several years past there has been almost none. At the moment, what with reduced appropriations and one thing and another, it is at almost an absolute zero. The rôle of the League ought to be to protect decent amateurs against tyrannical administration. We should not be forced by circumstances to be egging on the government to be stricter against us — it is almost ludicrous. Yet for years back we have had to do that thing, and we have the spectacle of the American Radio

Relay League going year after year to the Secretary of Commerce and later to the Commission and demanding of those worthies that they enforce the provisions of the Radio Act of 1927. Our Board of Directors has been impelled to this by self-defense, in the simple knowledge that the recalcitrants that always occur in any good-sized cross-section of humanity must be kept in check or they will spoil the game for all of us.

One cannot blame the district inspectors for this condition very much. The fault is at Washington, where there is a tendency to centralize everything, with reduced staffs and reduced appropriations and reduced apparatus in the field. The situation ought to be the reverse, for it is only from the field, and in the hands of resident

inspectors, that intelligent administration can be conducted.

Here we are, then, with a mounting total of amateurs, freely licensed (as is proper) and freely turned loose in hands under certain guarding regulations (as is proper), but with the government doing nothing about it from that point on. For the  $n^{\text{th}}$  time we rise in righteous indignation to demand, for our own good, that the Federal Radio Commission undertake the enforcement of the amateur regulations as called for in the law. And if they can't do it, then we want for radio amateurs the right of self-policing, with enough deputized authority to make our disciplinary measures stick.

K. B. W.

## World's Fair A.R.R.L. Convention

Chicago, August 3rd, 4th, 5th

ALL radio amateurs are invited and urged to attend this convention. It is being held at the height of the season at A Century of Progress Exposition.

With its hundreds of buildings A Century of Progress contains over 90 miles of displays. Dioramas portray the distribution of electricity and the execution of many other phases of modern civilization. Everything new and historical in radio will be there. Amateur stations W9USA and W9USB, located in the Amateur Radio Exhibit in the Travel and Transport Building, will be on a 24-hour-operation schedule throughout the Fair.

Special conducted tours for convention delegates will take visiting amateurs direct to all vital and interesting displays for radio men. There will be so many new things exhibited that these conducted tours will be most valuable. The convention program is being so balanced that attending amateurs can view all the significant features of the Fair, in addition to participating in all convention activities.

During the three-day convention the elimination trials and final selection of the amateur code speed champion of the world will be held. The award for this event will be a beautiful trophy offered by A Century of Progress.

There will be other events for which the prizes will be many and desirable. A balanced program of talks on all phases of radio will be of interest to all amateurs.

Make your reservations now. Sixty-five million people and 1400 conventions are scheduled to visit A Century of Progress this summer. The convention fee, which includes the banquet and trips through the Exposition, has been set at \$4.50. Mail in your check or money order now;

the ticket will be sent you immediately. Write to Wm. E. Schweitzer, W9AAW, 3800 North Western Ave., Chicago, Ill. Hotel accommodations are available at the convention headquarters, the Medinah Michigan Avenue Club, 505 N. Michigan Ave., at rates ranging from \$3.00 for single rooms to as low as \$2.00 each for groups of four per room. Special travel rates from all parts of the world will be in effect; ask your local transportation agent for special information.

Chicago will become the Mecca of hundreds of radio amateurs from all parts of the country during latter July and the first of August. Make sure that you will have a foremost place among them by making your plans and reservations now.

## Who Received the Message?

ALL the information needed to solve the problem is contained in the following story. Every statement has an important bearing on the solution. See if you can find who received the message.

Six active hams, W7DEF, W8GHI, W6ABC, W9JKL, W5MNO, and W7PQR had formed a relay network. All six handled traffic at every opportunity. W7DEF heard W8GHI sending CQ. W6ABC couldn't copy over 15 words per minute. A 30 word message was sent at 10 o'clock. W9JKL was near sighted. The message was received while W5MNO, with the curtain down to keep the sun out of his eyes, was eating crackers in bed. The receiver of the message noted the time on his watch across the room, and marked the time on the message as being received at 10.01. W7DEF worked every day in a shoe store, while his friend, W7PQR was out of a job. W8GHI was on the air from 9 to 11 p.m. every night, but only operated for the two hours. Who received the message?

— W6EIJ

Solution of this problem will be published next month. — EDITOR.

# OA4U—On the Roof of the World

By S. L. Seaton\*

TEN years ago the Department of Terrestrial Magnetism of the Carnegie Institution of Washington established a magnetic observatory at Huancayo, Peru, South America. One of the prime objects in establishing this observatory was the study of the earth's magnetic and electric fields and related studies at great altitudes. The observatory is located 11,000 feet above sea-level. The following years indicated the value of the determinations made at this site, and in 1931 experimental radio work was added to the program built up since 1921 to cover as many fields of geophysical research as possible.

The trip to the Huancayo Magnetic Observatory from the seaport Callao and through Lima is one of the most interesting in the world. In order to get there it is necessary to take the Ferrocarril Central de Peru (Central Railroad of Peru) and travel all day through the Scenic Sierra rising to heights of well over 16,000 feet. Leaving Lima at seven in the morning, one starts immediately to climb the western slope of the

the remainder damp and rainy. The radio building lies to the east of the main living-quarters and some 300 yards away. As you enter the laboratory, on the right will be found the operating table with the receivers, the controls for the transmitters,



NEAR TICLIO ONE REACHES 16,000 FEET, THE HIGHEST POINT OF STANDARD-GAGE TRACK IN THE WORLD



THE OPERATING POSITION AT OA4U

Andes. At about two in the afternoon you are near the top, Ticlio, the highest point of standard-gage track in the world at an altitude of 16,000 feet above sea-level. A headache, maybe, and loss of interest in the interesting views *en route* may prevent the traveler looking out of the window, but if courage enough is mustered one will be greeted by snow-clad peaks rising to heights of almost four miles. Huancayo is reached at nine in the evening and then it is necessary to drive in a car for fifteen kilometers, over roads equal to some in our old Virginia, to arrive finally at the station. Usually nothing further is done the evening of arrival except to partake of a cup of tea and turn in.

The morning following arrival will be marked by either rain, indicating that it is the rainy season, or by sunshine, showing that the dry season is at hand. Seven months of the year are dry and

and the pull-cords for the antenna-switch. On the left, and built into the wall of the room, is a cabinet for the spare instruments. Further along the wall is the small transmitter. Directly ahead there is a work-table where new circuits are made up and tried out.

On the right near the door to the generator-room is the main transmitter,<sup>1</sup> which is used for long-distance experimental work with Australia and the Philippines and other points in the West Pacific and also with stations to the east such as England and Finland. It works very well on 7, 14 and 28 megacycles as well as intermediate frequencies. The input runs from 150 to 500 watts depending upon the frequency of operation. The power is supplied by a Ford engine-driven 9-kilowatt 3-phase generator feeding a delta-connected bank of transformers for getting 110 volts for the receivers and the transmitters. A 120-volt battery, charged from the main machine through a suitable motor-generator, supplies lights for the house and power for the small transmitter through two dynamotors.

Directly behind the operating-room is the dark room for developing traces which will be made as soon as the equipment for measuring continuously the heights of the Kennelly-Heaviside layer is installed. The operator's living-quarters are to the south of the laboratory and consist of a bedroom and bath with a shower and continuous hot-

\* Department of Terrestrial Magnetism, Carnegie Inst. of Washington, Washington, D. C.

<sup>1</sup> Described in *QST*, June, 1931.

(Continued on page 31)

# The Micrometer Frequency Meter

Improving Accuracy to Make More Operating Territory Available

By G. F. Lampkin, W8ALK\*

**A**LTHOUGH it has been emphasized in *QST*<sup>1</sup> and in *The Radio Amateur's Handbook*<sup>1</sup> that the portion of our amateur bands actually available for our individual use is limited by the accuracy of the frequency measuring equipment we happen to have on tap, the full significance of this important fact is not generally

THE MICROMETER CONDENSER IS CONTAINED IN A CAST ALUMINUM BELL WITH THE MICROMETER HEAD PROJECTING FROM THE TOP

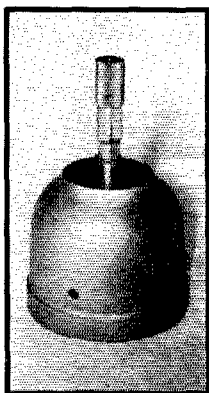

realized. With the better frequency meters (such as the electron-coupled type described recently in *QST* and in the *Handbook*) having accuracy dependable to within  $\frac{1}{10}$  of 1%, one can feel secure in tuning a transmitter to within only that percentage of a band limit. On the 80-meter band, for instance, with a frequency meter of this accuracy it is unsafe to tune closer than within 3.5 kc. of 3500 kc. or within 4 kc. of 4000 kc. Otherwise there is the liability that the transmitter frequency may fall outside the band altogether. On the higher frequency bands the number of kilocycles that would have to be left in the doubtful regions becomes proportionately greater. Hence, for the four amateur bands from the 1750-kc. to the 14-mc. inclusive there must be a total of almost 54 kilocycles unavailable to the amateur whose frequency meter is accurate to no better than  $\frac{1}{10}$  percent. With meters of lesser accuracy the unavailable marginal territory must be proportionately greater.

It is apparent, then, that further improvement in frequency meter accuracy will be repaid in additional operating territory made available.

\* Consulting Engineer, 146 W. McMillan St., Cincinnati, Ohio.

<sup>1</sup> Grammer, "Bringing Frequency Measurement Up To Date," *QST* Sept., 1930; and Chapter VI, *The Radio Amateur's Handbook*, Ninth Edition.

The factors determining accuracy all must be recognized and coordinated. These are accuracy of the source of calibration, precision in setting and readability of the calibration scale and charted curve, and stability. In the heterodyne type meter the frequency stability depends primarily on electrical effects and mechanical effects, the latter being principally a function of temperature. In the micrometer frequency meter these factors have been recognized and coordinated with minimum of expense. The result is an improvement of over 6 times in the dependable accuracy. The necessary precision in setting and readability is provided by a micrometer type condenser while the stability has been improved first, by proper proportioning of the supply voltages on the electron-coupled type oscillator and second, by a temperature compensating condenser.

## THE MICROMETER CONDENSER

In Fig. 1 is shown a sketch of the micrometer condenser about which the frequency meter is built. The micrometer head is made a force fit into the aluminum bell casting. On the micrometer spindle is mounted a cylindrical aluminum rotor so that it may travel in and out of a short piece of aluminum tubing. The latter forms the stator plate, and is supported and insulated by

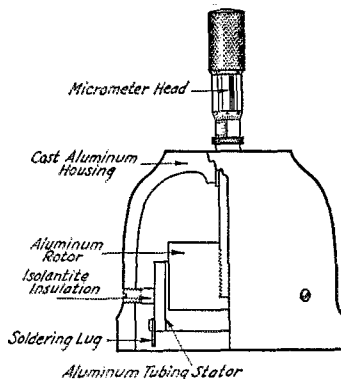

FIG. 1 — DETAIL OF THE MICROMETER CONDENSER

Isolantite beads forced in by setscrews through the wall of the casting. The length of travel of the rotor in or out of the stator, and thereby the capacity of the condenser, is measured on the micrometer scale. The whole makes a rugged and sturdy assembly, though hardly in the form

usually associated with a precision variable condenser.

Both rotor and stator are slightly more than 1 inch long, in order that over the entire 1-inch travel of the micrometer spindle the capacity will vary linearly without "bending" because of end effects. For the construction pictured the measured maximum and minimum values of capacity are respectively 50.3 and 17.6  $\mu\text{mf}$ . The construction shown allows the micrometer condenser to be mounted either above or below the panel, the cast housing giving perfect shielding against external capacity effects. The condenser can be used in a vertical or horizontal position.

It is important that the machine work going into the construction of the condenser be of the best. The rotor must run true to less than one-thousandth inch, and the stator must be concentric with the rotor to the same tolerance. The effects of inaccuracy in machine work are worst when the rotor and stator are fully engaged, for two reasons: one, if the spindle arm is out of true, and is fully extended, it will have the greatest throw from side to side; the other, since the effective dielectric area is at a maximum, any eccentricity of the rotor will cause a maximum wobbling in capacity, over one revolution of the spindle. If the stator is not concentric with the rotor, its misplacement will greatly magnify even a slight eccentricity of the rotor.

Measurement of wobbling in terms of capacity is difficult, since the values involved are of the order of .01  $\mu\text{mf}$ . However, in the frequency meter one revolution of the spindle corresponds to a frequency change of about ten kilocycles, and over this limited range the change in capacity is strictly proportional to the change in frequency. In Fig. 2, *a* shows the frequency calibration at intervals of one-thousandth inch, over one revolution of the spindle near the maximum-

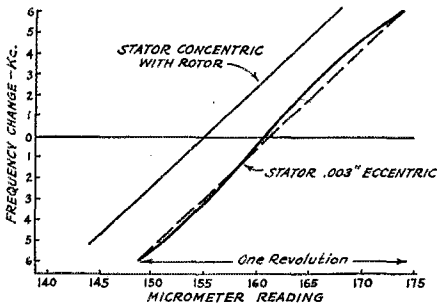
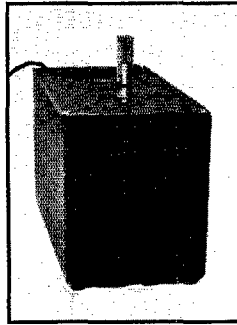

FIG. 2—ECCENTRICITY IN THE MICROMETER CONDENSER CAUSES A "WOBBLY" CALIBRATION CURVE

capacity position. The curve shows no wobbling whatever within the limits of observation. If, however, the stator be no more than three-thousandths inch off center, the calibration re-

sulting is that of *b*, which could add an error of 800 cycles to a frequency determination.

The micrometer can be had with a scale reading 0 to 1000, or 0 to 2500. In the former case, each division is over  $\frac{1}{16}$ -inch wide, and there are 1000 of these full-sized divisions. Therein lies the inherent reason for the precision of the micrometer frequency meter. The developed scale length of the micrometer condenser is 64.4 inches,



THE MICROMETER FREQUENCY METER IS COMPLETELY SELF-CONTAINED AND MEASURES ONLY 10 BY 5 BY 6 INCHES

whereas that of a 6-inch dial over  $180^\circ$  is only 9.4 inches, and of a 4-inch dial 6.3 inches. If a dial were made having a scale length equivalent to that of the micrometer, it would be 41 inches in diameter!

The micrometer might be equipped with vernier reading to ten-thousandths but, as will be seen later, this would be superfluous. The errors due to estimated readings to ten-thousandths on the 0 to 1000 scale are less than those due to temperature or calibration. Since the capacity varies linearly up to and past the ends of the scale, the frequency band may be spread over the whole scale rather than over the usual 80 or 85 percent. When the micrometer reads zero, the rotor and stator are fully engaged and the capacity is a maximum. As a result, the frequency calibrations vary directly as the dial reading, an increase in reading giving an increase in frequency. Finally, the micrometer head is built so that changes of two or three divisions in the calibration may be corrected without having to draw complete new calibration curves. The longitudinal scale and index line on the micrometer are carried on a thin sleeve. With a small spanner wrench this sleeve may be slipped around and the index lined up to correspond to the calibration. By periodically checking the meter at one high and one low point, and resetting if necessary, the old calibration curves may be used much longer than otherwise.

Such is the micrometer condenser. It may be applied to existing frequency meters, where its open scale will be appreciated. In spite of the length of the scale, it does not take long to go from one end to the other; when the spindle is rotated the inertia of the rotor helps to keep it spinning on through the range, and the action

is not to be compared to that of a 40-to-1 ratio dial, for instance.

#### THE FREQUENCY METER CIRCUIT

To match the precision of the micrometer condenser, however, requires new design on the frequency meter circuit. By "new" is meant

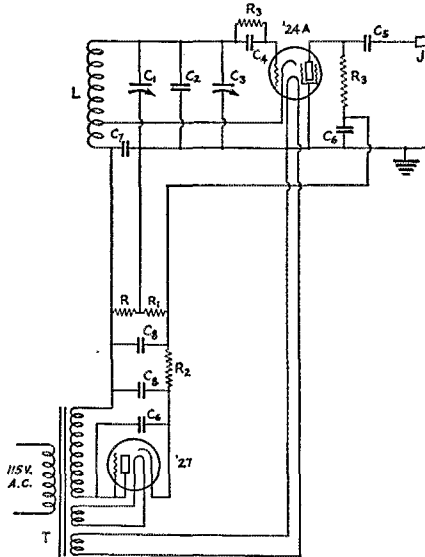

FIG. 3 — CIRCUIT OF THE MICROMETER FREQUENCY METER

- C<sub>1</sub> — Micrometer condenser.
- C<sub>2</sub> — Automatic temperature compensating condenser.
- C<sub>3</sub> — Hammarlund MC-100-M midget condenser with rotor lock.
- C<sub>4</sub> — 100- $\mu$ fd. moulded mica condenser.
- C<sub>5</sub> — Twisted hook-up wire 5 inches long.
- C<sub>6</sub> — .004- $\mu$ fd. mica bypass condenser.
- C<sub>7</sub> — .01- $\mu$ fd. mica bypass condenser.
- C<sub>8</sub> — 2- $\mu$ fd. 400-volt filter condenser.
- L — 59 turns No. 32 s.c.c. close wound, 1 inch dia., tap 19 turns up.
- R — 3000-ohm metallized 1-watt resistor.
- R<sub>1</sub> — 50,000-ohm metallized 1-watt resistor.
- R<sub>2</sub> — 5000-ohm metallized 1-watt resistor.
- R<sub>3</sub> — 100,000-ohm metallized 1-watt resistor.
- J — Yaxley insulated tip jack.
- T — Transformer, 115-v. 60-cycle to 165/2.5/2.5 v.

actually a departure from commonly accepted present-day amateur practices. However, there is nothing complicated in either the construction or the technique, and the same fundamental principles still apply. The result is a self-contained micrometer frequency meter, no larger than 10 by 5 by 6 inches. It is completely a.c. operated, requires no batteries or other external apparatus, and can be used five minutes after tuning on. The m.f.m. is automatically compensated for temperature changes, is compensated for line voltage changes, and, as seen above, can be corrected for aging. It is proof against ordinary mechanical shocks and stresses, and has both precision and stability such that frequencies in the

3500 kc. band can be determined to  $\pm 500$  cycles, or with an error of not more than .015 percent.

#### CONSTRUCTIONAL LAYOUT

The circuit of the meter, shown in Fig. 3, is essentially that used in the WIMK electron-coupled frequency meter described in July, 1932, *QST*, and in the *Handbook* (tenth edition). The oscillator works on fundamental frequencies in the 1715-kc. band, although calibrations are made and used on the 3500-kc. band. A midget condenser is used for a padding and "spotting" condenser in the oscillator tank. One side of the filament of the oscillator is grounded directly rather than through mica bypasses, since there was found no operating difference in the two methods. The output coupling condenser is made of two pieces of push-back hook-up wire twisted together for 5 inches. This construction has a capacity of 1.3  $\mu$ fd. per inch. Alternatively, two pieces of No. 14 solid bus wire laid together with one layer of spaghetti between them would have a capacity of some 1.7  $\mu$ fd. per inch.

A small power transformer, a '27 rectifier, a resistance-capacity filter, and a potential divider constitute the power supply. The .004- $\mu$ fd. mica bypass across the rectifier is useful in removing the last small vestige of raggedness in the note.

During the development and use of the m.f.m. it was found that after the parts had warmed up for a while, any slight jar would hop the frequency several hundred cycles, and continued shocks would change it by as much as two thousand cycles. This happened, not with a fixed mica tank condenser, but only when using the midget variable as tank condenser. The cure was found to be a lock on the rear bearing, made in the manner of the sketch in Fig. 4. It was not a case of rotation of the rotor, for a lock at the front bearing had no effect. Rather it was movement of the bearing lock completely eliminates frequency shifts due to mechanical shocks, and, of course, also permanently fixes the position of the rotor plates.

Not a small contribution to the mechanical stability is given by the cast aluminum shield box. The walls are  $\frac{1}{8}$ -inch thick, all one piece with no

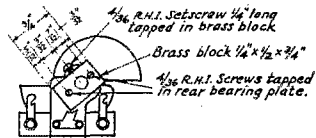

FIG. 4 — DETAIL OF THE ROTOR LOCK FOR THE MC-100-M TANK CONDENSER

joints or cracks. The rigidity is such that pressure anywhere on the box itself has zero effect on the frequency, although heavy pressure on the  $\frac{1}{8}$ -inch aluminum panel may change the fre-

quency 30 or 40 cycles at 3500 kc. The cast box is fitted with small rubber feet screwed in from the bottom. Three fibre washers, whose function will appear later, are used to space the micrometer condenser from the panel. Two vents, screened with perforated brass sheet, are cut,

Type 24A electron-coupled oscillator was supplied from a separate filament transformer. The plate voltage was supplied directly from the "B"-eliminator and the screen voltage from a tap on a 50,000-ohm potentiometer across the eliminator. For different positions of the screen tap, the frequency variation was measured against varying a.c. line voltage.

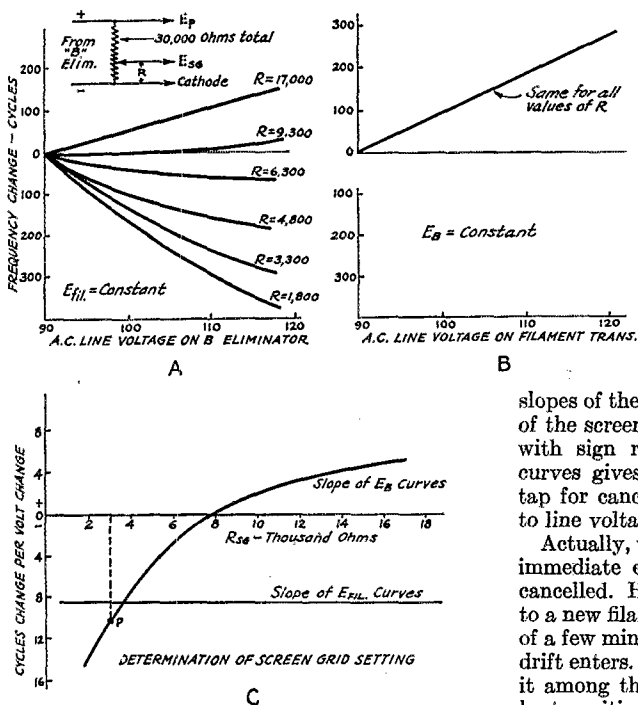

FIG. 5 — THE EFFECTS OF VOLTAGE VARIATION ON FREQUENCY

one in the base of the box casting and one in the panel, for ventilation.

#### VOLTAGE COMPENSATION

In describing the electron-coupled oscillator, Dow showed that by properly proportioning the screen and plate voltages frequency variations due to these factors could be cancelled out.<sup>2</sup> If filament, screen, and plate voltages are all secured from the same source, one or other of the latter may be over-emphasized so as to make the cancellation cover all three factors.

All values of frequency variation given hereafter are referred to 3500 kc. The frequency variations were measured by beating the m.f.m. against 3500 kc. from a precision, temperature-controlled crystal oscillator, and measuring the tone with a beat-frequency oscillator. Short time measurements could be made with precision of five to twenty cycles.

To determine this optimum condition, the

frequency variation was measured against varying a.c. line voltage. This procedure gave the curves of Fig. 5A. Next, the line voltage on the "B"-eliminator was held constant, while that on the filament-transformer primary was varied. The resulting frequency variation is shown by 5B, which curve was the same for all positions of the screen tap. To make the effect of combined screen and plate voltage cancel that of the filament voltage, one of the curves of 5A must be picked whose slope is equal and opposite to that of 5B. This is most easily done in 5C, where the

slopes of the A curves are plotted against position of the screen tap; also is plotted the slope of B, with sign reversed. The crossing of the two curves gives the correct position of the screen tap for cancelling out frequency variations due to line voltage shifts.

Actually, when the tap as indicated is tried, the immediate effects of a line voltage change are cancelled. However, as the tube adjusts itself to a new filament temperature, requiring a period of a few minutes, another new cause of frequency drift enters. Recognizing this cause and including it among the factors to be cancelled places the best position for the screen tap at the point P, whereby the resistance values in the potentiometer are determined. The resulting d.c. plate and screen voltages from the eliminator shown are 185 and 10 volts, respectively. The low screen voltage cuts the strength of the harmonics on the 14- and 28-mc. bands somewhat, but leaves a sufficiency to work with.

Editor's Note: In a second article, to follow in an early issue, the author will describe the simple method of automatic temperature compensation and give instructions for precision calibration of the micrometer frequency meter.

## Strays

A simple arrangement for keeping the filaments from blinking when the transmitter is keyed is to wind a few extra turns on the core of the power transformer, if space will permit, and connect them in series with the primary of the filament transformer. Three or four turns usually is enough. The key should be in the primary circuit of the power transformer.

— W7ASQ

<sup>2</sup> QST, Jan., 1932.

# An Unusual 56-mc. Super-Regenerative Receiver

Details of a Portable Set With Self-Quenching Detector

By J. G. Haydock, Jr., W3ACD\*

**I**N ORDER to obtain super-regeneration it is necessary to upset the normal oscillations of the detector in such a fashion that they are never permitted to grow to a fully sustained steady state. The oscillations are allowed to build up to a value approaching the steady state and then by either reducing the plate voltage or raising the grid bias the tube is suddenly rendered incapable of oscillating. This condition is maintained while the free oscillations in the tuned circuit die out. Then the proper voltages are restored and oscillation begins to build up again. To obtain this effect, some method of periodically varying plate voltage or grid bias is needed. In the super-regenerative receivers commonly used by amateurs, it is generated by a separate tube. In the receiver to be described, it is generated by the detector tube itself.

Where weight and battery limitations are severe, it is obviously desirable to dispense with the separate oscillator tube and to use the type of detector which generates its own quenching voltage.

Those who have made regenerative receivers for the lower frequencies doubtless remember that too much feedback often causes the detector to squeal. This phenomenon is caused by an excessive accumulation of electrons on the grid condenser which increases the negative bias on the tube, stopping oscillation in the tube momentarily until the bias is reduced by drainage through the grid leak. The frequency of this trigger action depends on the sizes of grid condenser and leak and on the  $L/C$  ratio of the tuned circuits and can be made to meet the requirements of super-regeneration.

Quenching of this type is used in the portable receiver illustrated. The circuit diagram, Fig. 3, shows the tuned-plate tuned-grid detector and the audio amplifier. Two Type 30 tubes are used.

The detector is constructed as an integral unit. The wafer tube socket serves as a support for the flat copper strip coils which are soldered to

\* 316 Kings Highway, East, Haddonfield, New Jersey.

eyelets. To permit single-dial control the grid and plate tuning condensers are ganged. For compactness a standard 7-plate Isolantite insulated condenser was used. Screws pass from the tube socket through metal stand-off sleeves to the end frame pieces of the condenser which is stiffened in addition by a small bakelite strip which holds the bearings in line. The middle rotor plate has been removed and the brass stator support rods have been sawed in two, making a compact double stator condenser of about 20  $\mu$ fd. per section. Each section tunes one coil. The shaft of the condenser is placed parallel to the center line of the plate and grid pins of the tube to make the leads the same length. The coils are flat copper strip cut from No. 20 gauge stock. The fixed mica grid and blocking condensers are made up as one unit. This is not essential from the performance standpoint but does shorten the tuned circuits somewhat.

The arrangement of parts of the detector unit is very similar to their location on the wiring diagram. Close examination of Fig. 1, which shows the plate and grid terminal side of the detector socket, illustrates how symmetrical connections to the tube, coils and condenser is obtained. Symmetrical location of the plate and grid blocking condensers is also important. They are not visible but are placed on the under side of the socket on a line parallel with the filament pins of the tube. In building sets of this type the general idea of this layout of parts might well be followed closely.

The entire unit is mounted on a heavy brass bracket attached to the base, using the regular one hole mounting fittings of the condenser.

The battery cable sheath is the ground lead. It is carried into the set through one of the five connector pins. Inside the set this ground lead goes directly to the condenser shaft contact, making the detector mounting bracket the only ground connection to the cabinet. The leads of the variable grid leak need not be short, and are made of twisted pair.

The antenna is directly coupled, a lead to the pin jack antenna terminal being soldered to the

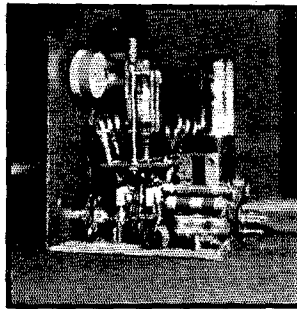

FIG. 1 — A SIDE VIEW OF THE PORTABLE "SELF-QUENCHING" SUPER-REGENERATIVE RECEIVER



grid coil. The proper location for this connection must be determined by trial for the type of antenna to be used.

The audio amplifier circuit is somewhat unconventional. Bias is obtained with a 750-ohm resistor which carries the plate current of both tubes. The resistance-capacity shunt across the

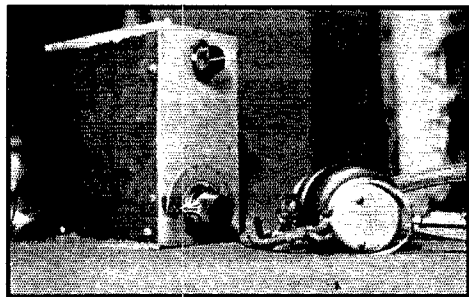

FIG. 2—A PAIR OF PHONES AND THE COMPLETE RECEIVER

transformer secondary is intended to deaden the hiss and reduce the intensity of the interruption frequency voltage appearing as excitation on the amplifier. The values given for this shunt are correct for the interstage transformers used (they were taken from a Radiola 28), but will be approximately so for any transformer of comparable ratio.

Being designed for operation on a small one cell lead storage battery this set has no filament rheostat. For two dry cells a 10-ohm variable resistor should be used. It need not be accessible from the panel.

This receiver is about the limit of compactness for the tube types now available and any closer clearances between the detector coils and surroundings probably would be undesirable.

The first tests of the set should be made with the antenna disconnected. With a small amount of grid leak resistance the detector should oscillate in the normal manner, as indicated by any of the usual tests. As the grid leak resistance is increased a sharp click will be heard, which is the beginning of trigger action. As the resistance is further increased, the hiss should become louder. With the full 500,000 ohms a high pitched squeal should be audible. The next step in the preliminary test is to determine the tuning range and adjust it to cover the band properly. The coils will bring the range close enough so that it will be necessary only to squeeze the turns closer together if the receiver does not tune to a low enough frequency or spread them apart if the reverse is true.

The tracking of the two tuned circuits may be checked in one of two ways. Press the turns closer together on one coil and note whether the hiss becomes louder or weaker. If it becomes weaker, pull the turns apart until it becomes weaker again

after passing through a point of greater intensity. The point of greatest hiss intensity is the proper adjustment. In the other method a milliammeter is connected to read detector plate current and the spacing of the turns of one coil is adjusted until it is a minimum. These adjustments should be made with some non-conducting tools.

Having completed these adjustments, the proper point to attach the antenna should be determined. Start with it just above the point where the grid coil is connected to the grid condenser. Move it step by step toward the grid end of the coil until the farthest point is reached where the receiver will super-regenerate properly over the entire tuning range.

In operating, there are two controls: tuning and quenching frequency. When tuning, the variable grid leak should be set at the point where the hiss is loudest. When a signal is heard the grid leak may be adjusted for best signal strength. This indicates that too little grid leak resistance is being used, or sometimes that the plate or filament voltages are low.

This set may be used on any of the nonsymmetrical antennas. The writer usually uses a single wire feed half-wave type 8 feet long with the feeder attached 19 inches off center. A vertical

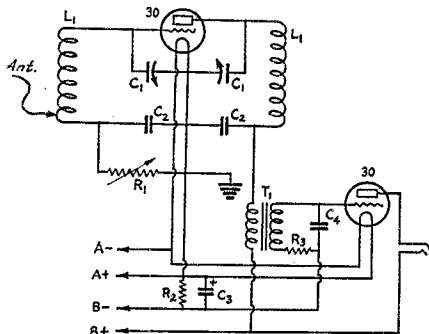

FIG. 3—THE CIRCUIT

- $L_1$ —3 turns  $\frac{1}{8}$ " wide No. 20 gauge copper strip,  $\frac{1}{8}$ " in dia.
  - $C_1$ —20  $\mu\text{fd}$ . per section rebuilt 7 plate Hammarlund midjet condenser.
  - $C_2$ —.001- $\mu\text{fd}$ . mica condensers.
  - $C_3$ —4- $\mu\text{fd}$ . dry electrolytic condenser.
  - $C_4$ —.003- $\mu\text{fd}$ . mica condenser.
  - $R_1$ —0-500,000-ohm variable grid leak.
  - $R_2$ —750-ohm carbon stick resistor.
  - $R_3$ —20,000-ohm carbon stick resistor.
  - $T_1$ —1/2.5 interstage audio transformer.
- Plate voltage 67-90 volts.  
Plate current 3-5 milliamperes.

8 foot wire may be used, plugged into the antenna terminal, but for best sensitivity the tap on the grid coil will have to be moved farther over toward the grid end than for the single wire type. A one-quarter wave antenna usually must be attached somewhere on the lead from the junction of the two mica condensers to the condenser shaft to avoid loss of super-regeneration.

In performance, this receiver has proved very

satisfactory. It has not failed, so far, to produce intelligible speech from any signal which could be understood on more complex super-regenerators. On account of the reduced hiss it is a very comfortable set to use with headphones, and the filter in the audio systems absorbs enough of the inaudible quenching voltage so that the amplifier has capacity to handle louder speech with less distortion than many receivers which have been tried.

Comparisons between this receiver and ones using separate quenching oscillators shows that there is slightly more sensitivity available in the latter. On account of the noise conditions at all but the most remote locations, however, it is doubtful if that additional sensitivity is really usable.

### More DX on 56 Mc.

THE airplane 56-mc. tests announced in May QST and run off on schedule on May 7th, aroused terrific interest on the part of New England's 56-mc. workers. During the one-hour flight from Natick, Mass., to Providence, R. I., W10XU-W1COO worked 16 stations—a very insignificant fraction of the number of stations calling him. The best DX contact was with W1FEX on Mt. Washington. Also flying with 56-mc. gear on the same afternoon were W1XL (Conn. State Department of Aeronautics) and W10XAQ (Westinghouse Electric & Mfg. Co.). Of the swarm of stations participating, only one, as far as we are aware, has the distinction of having worked all three planes. W1AWW, pioneer 56-mc. station on Wilbraham Mountain, picked the plum.

In California, where one can grab off a couple of mile-high mountains without any particular inconvenience, there are magnificent opportunities for 56-mc. DX. Recently, two groups of members of the Cogswell Radio Society, San Francisco, set out to exploit these opportunities. They succeeded in working solid duplex between the two points chosen—Blue Canyon, a town located one mile high in the Sierra Nevada Mountains, and Mt. Diablo, 3850 feet high. The distance covered was 120 miles.

Transmitters at both stations were m.o.p.a. rigs with Type 10's as output amplifiers modulated with Type 46's. After the first contact, directive antennas were strung up and found to provide an enormous gain in signal strength. Voice signals were readable 200 feet from the loud speakers. The amateurs responsible for the work were Frank Kirby, W6WI; Charles Moody, W6HEV; Russell Brosamle; Lloyd Case and Arnold Stenfors.

\*This station and its activities were described in the March, 1933, QST.

W1FEX\*, station of the International Polar Year group on Mt. Washington, N. H., continues to set the pace for 56-mc. DX. Most notable exchange of strong signals has been with W1ASF-W1CSP at a distance of 142.5 miles. Innumerable other contacts have been established over distances above 100 miles. According to present plans, the station will continue to be operated during the summer with additional equipment on the 28-mc. band.

U. S. amateurs by no means alone in their exploitation of the 56-mc. band for airplane work. A recent report received from the R.S.G.B. tells of G5CV, flying at 10,000 feet over the North Sea, receiving good signals from G6QB, 130 miles away. Input to the transmitter at the time was 10 watts.

### Kansas National Guard Station CX7

AMATEURS often have shown stellar performance to the general public in time of emergency—have always been only too glad to display their skill. The A.A.R.S. and U.S.N.R. systems appeal to many hundreds of amateurs for year round drills for they are only too glad to be of service to Uncle Sam. So it is little wonder that the amateurs in the 169th Infantry, Kansas National Guard, in cooperation with other Kansas amateurs did such excellent work and turned in a record total of traffic. This is an old story to those in the middle west, is a bit of past history, but we think that the work rates more than local interest and commendation for in four weeks activity CX7 handled over *six thousand two hundred* messages, for an average of 223 messages per day with scheduled stations. Will this record be broken this summer?

The operators at CX7 under the supervision of Lt. Col. McFarland, W9EVT, and Chief Operators Lt. Evans, W9DKI and Lt. Beasley, W9FRC were: W9ESW W9ICV W9BGL W9HLZ W9DCB W9AWP W9CUF W9NV W9DQF and Commercial Operator Leslie Bieble.

It would seem an excellent project to be undertaken by National Guard camps in all parts of the U. S. providing the amateurs in these various outfits were interested enough to exploit the idea to those in charge.

The Kansas gang gave this idea a great deal of thought and schedules were lined up considerably in advance with reliable operators at various stations around the state. One can gain some idea of the scope of contact around the state when it is pointed out that schedules with eighteen different cities were kept each day. This large number of daily schedules necessitated something other than just a typewritten list. An attempt was made to procure a 24-hour clock but none could be found so an electric clock was used that had a 12-inch

(Continued on page 28)

# Twisted-Pair Feeders for the Transmitting Antenna

By George Grammer, Assistant Technical Editor

THE efficiency and flexibility of the Zepp feeder system have been demonstrated conclusively over a period of several years, but the feeders themselves still have some undesirable mechanical features. The ideal feeder construction is one which is light in weight and yet is so made that the two wires are rigidly held at a fixed separation. The wires must not swing with respect to each other or there will be a change in their mutual capacity, which reflects itself as a change in transmitter frequency if the antenna is being fed by a self-excited oscillator. Likewise, the feeder system as a whole must not swing with respect to surrounding objects or a similar capacity change will take place. The ordinary type of Zepp feeder construction in which the wires are held apart by spacers several inches in length is seldom free from either of these defects.

It would seem that a feeder system which really was a unit instead of a loose-jointed affair resembling a mechanical dancing toy would be a distinct improvement. That, at least, has been the opinion of a number of people who have endeavored to make the feeder a unit by twisting the two feeder wires together. The use of twisted pair or other types of double-conductor cable for transmitting radio-frequency power is not a new idea — we have used short pieces of lamp cord to make up deficient feeder lengths temporarily for a number of years — but so far as we can find no one has published any information about the losses in such feeders in comparison with those of the ordinary spaced-wire design.

One obvious characteristic of a feeder system made of two-conductor cable is that it will have a great deal more self-capacity than a spaced feeder. One reason, of course, is that the wires are much closer together; the other is that because they are so close together there must be some insulating material between them to keep them separated, and practically all insulating materials have a higher dielectric constant than air. We might expect, therefore, that a "twisted pair" (used here to indicate any type of double-conductor cable) feeder would be shorter in actual feet than a spaced-wire line of the same electrical length. Unfortunately, too, we might expect that the losses in such a line would be greater than in the spaced line because all insulating materials have greater losses than air. The greater self-capacity of the line also will mean

that the circulating current will be large, thus pyramiding the losses. The actual facts bear out these expectations.

## DUMMY ANTENNA TESTS

To get some information on the behavior of different types of lines the test circuit of Fig. 1A was rigged. The driver was a crystal-controlled transmitter having an output of about 100 watts, the frequency being in the 7-mc. band. The standard of comparison was a quarter-wave spaced feeder of two No. 12 wires each 33 feet long built as an ordinary feeder with the 6-inch

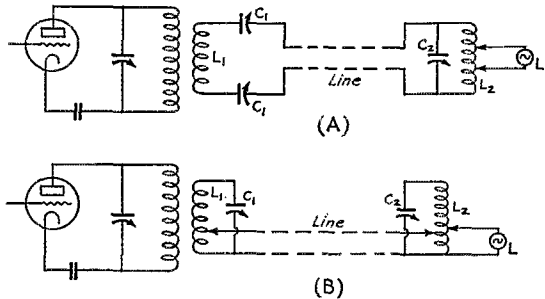

FIG. 1 — THE PRELIMINARY FEEDER TEST CIRCUIT USING A LAMP AS A DUMMY ANTENNA

porcelain spacers made by E. F. Johnson. The input to the line was series-tuned by the condenser marked  $C_1$  and at the receiving end a low- $Q$  parallel-tuned tank circuit,  $L_2C_2$ , was used to simulate an antenna. A 150-watt lamp served as a dummy load. The feeders were connected directly across the ends of the coil and the number of turns included between the lamp terminals adjusted for maximum power.

Three types of two-conductor wire were tried. One was the ordinary No. 14-equivalent twisted lamp-cord (the kind with the green-yellow cotton cover on each wire) with rubber insulation; the second was a heavier twisted cord moulded in rubber; the third, ordinary No. 14 solid wire with rubber and weatherproof covering, the type used for outside 110-volt wiring and for open house-wiring. We shall call them Nos. 1, 2 and 3 respectively.

The first observed fact was that conductors Nos. 1 and 2 could not be 33 feet long and work as quarter-wave feeders with the same approximate settings of the series tuning condensers

which gave resonance with the spaced-wire feeders. Clipping off a foot or two at a time finally brought the length down to a quarter wave; at this point No. 1 was 27 feet long and No. 2 was 21 feet. No. 3 apparently needed no pruning, for it tuned nicely at the 33-foot length, indicating lower capacity than the other two.

The efficiency of all three lines tuned as Zepp feeders was very noticeably poorer than that of the regular spaced wires. The lamp would light brilliantly with the latter, but the best that could

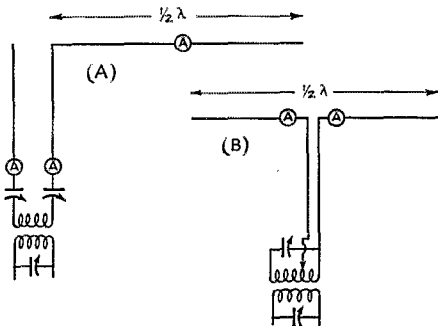

FIG. 2 — THESE CIRCUITS WERE USED FOR TESTING WITH RADIATING ANTENNAS

The Zepp system is shown at (A); center-fed antenna with untuned transmission line at (B).

be done with the three two-conductor lines was a reddish glow. Using the tuning system shown at Fig. 1B, with impedances matched at both ends and the line therefore non-resonant, gave an entirely different set of results, however. In this case the power transfer was practically the same with all lines so far as could be judged by watching the brilliance of the lamp.

Further investigation of aperiodic lines showed that the tuned circuit (really a matching transformer) at the receiving end of the line could be dispensed with when the two-conductor lines were used, the lamp being connected directly across the ends of the line. By visual observation the power transferred was as good as if not better than with the tuned circuit, indicating that the lamp impedance approached the characteristic impedance of the line. Since the line has no tuning effect under these conditions a further check was made using a twisted-pair line approximately 70 feet long. Again judging visually, the power delivered to the lamp at the end of the longer line was practically the same as with the shorter one.

The interesting feature of the two-conductor untuned lines was the fact that the lamp resistance under the conditions outlined above was between 50 and 100 ohms and therefore of the same order as the resistance of a half-wave Hertz antenna at the center. This opened up the possibility of a simple method of current-feeding a half-wave antenna with a twisted-pair line without an

impedance-matching transformer at the antenna end.

#### CHECKING WITH AN ANTENNA

So far observations had been made only with a dummy antenna, which probably had characteristics sufficiently different from those of a regular antenna to make a recheck under operating conditions advisable. Accordingly a half-wave antenna 66 feet long was constructed and strung up temporarily on the roof of the building. An ammeter at the center permitted comparative observations of the power delivered to the antenna by the various types of lines.

For the sake of clarity it is perhaps advisable to point out here the difference between the "Zepp" feeders and the "aperiodic," "untuned" or "matched-impedance" line. A Zepp antenna is a voltage- or end-fed antenna with a two-wire resonant or tuned line. The r.f. potentials on the feeders are different at every point, increasing to maximum at the antenna end. The untuned line, on the other hand, can have any random length, carries the same r.f. potential all along its length, and must be terminated at the antenna in such a way that the antenna impedance at that point is equal to the characteristic impedance of the line. The same pair of wires can be used in both ways; the way they work depends entirely on the method of terminating them at the antenna.

The antenna current reading with the spaced Zepp feeders was taken as a standard. Only two two-conductor lines were used, Nos. 1 and 3, since No. 2 had already shown itself to be definitely inferior to the other two as a Zepp feeder. Although some reduction in antenna power was to be expected, comparative figures using the twisted lines as Zepp feeders were rather surprising — disagreeably. With the twisted lamp cord the antenna current was only 30% of that obtainable with the spaced feeders — in other words, over nine-tenths of the available power was being wasted in the feeders. That there was nothing imaginary about this power loss was evident from the amount of heat developed in the feeders themselves; the entire length became noticeably warm after the transmitter had been running a few minutes. Evidently the twisted lamp cord did not shape up so well as a Zepp feeder.

The hand-twisted solid No. 14 rubber-covered wires were not quite so bad — only four-fifths of the available power was lost in heating the rubber insulation — but still had far too much loss to be considered seriously for end-feeding an antenna.

One misleading feature about two-conductor Zepp feeders is that the feeder current at the transmitting end is much higher than is to be expected with spaced feeders. This is the natural result of the high mutual capacity of the wires.

It looks fine in the station — but doesn't mean a thing in the antenna.

It seems that the answer to the swinging Zepp feeder problem is not a two-conductor cord — unless somebody devises a way to make such a cord without solid insulation or with an insulating material which has losses low enough to be comparable with air and at the same time not susceptible to moisture. Such wire may actually be available, but we have not been able to obtain anything like it in canvassing local supply houses. It has been suggested that small glass or Pyrex beads with holes spaced a half inch or so apart plentifully sprinkled along feeders made of regular enameled wire would do the job satisfactorily. This, it seems to us, would be a highly practical way of getting close wire spacing with the wires held rigidly apart.

#### UNTUNED FEEDERS

With negative conclusions being reached on the Zepp proposition, the investigation was carried further to determine how closely the twisted line matched the center impedance of the half-wave antenna and to get some idea of the efficiency of this type of line. Since the characteristic impedance of the line is low, the r.f. voltage between the wires also will be low when the line is properly terminated, and the line therefore has a better chance to work well than when used as a Zepp feeder.

The comparisons were made using the same antenna and driver with the feed circuits shown in Fig. 2. The two-conductor line is shown at (B), the spaced Zepp feeders at (A). Two ammeters were used at the center of the antenna to make sure that the current distribution was what it ought to be — or in other words that the line and antenna impedances were somewhere near to being matched. The results were what had been hoped for after the observations made with the lamp dummy antenna recounted previously. The untuned twisted lines showed just about the same efficiency as the spaced Zepp feeders; that is, the antenna currents were practically the same with both systems, the power input at the driver being kept constant.

Different types of two-conductor cords naturally have different impedances, but the impedances are all low and several types tried worked very satisfactorily in putting power into the antenna with negligible losses. The hand-twisted No. 14 wires seem to be about the best, with twisted lamp cord a close second. The former are likely to be better for year-round service, since the solid wire is made for outdoor work. Two varieties of shielded wire of the type used for auto ignition systems also were tried, the single inside wire being used for one feeder and the outer metal braid covering as the other. Both these also gave good results, although the efficiency was not quite as good as with the twisted wires. It is

questionable whether the "mesh" shield would maintain its conductivity when exposed to the weather, and since the r.f. conductivity is a somewhat doubtful quantity even under the best conditions, it would seem preferable to use the ordinary twisted wires.

Feed lines of this type have two excellent characteristics — they can be any convenient length since they are not tuned; and for all practical purposes the lines are "dead"; that is, the voltage is low and the capacity effects to surrounding

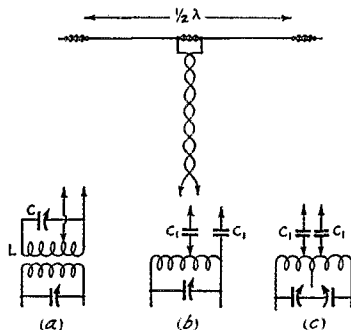

FIG. 3 — THREE METHODS OF COUPLING THE UNTUNED LINE TO THE TRANSMITTER

objects are negligibly small. The line actually can be picked up, handled, draped on grounded metalwork and in general treated just like an ordinary 110-volt line without visibly affecting meter readings in the transmitter or antenna. No particular insulation is needed beyond that on the wires themselves.

Against this — is there always a catch somewhere — is the fact that a low-impedance line feeding the center of the antenna is all wrong for working on even harmonics so that an antenna fed by such a line becomes a one-band affair for all practical purposes. Naturally this is a disadvantage which throws out this type of feeder if the transmitter is to be shifted from band to band. On the other hand this feature may be helpful if only one band is customarily worked by the transmitting station, because an antenna so fed will discriminate against even harmonics and thus reduce harmonic radiation.

For the benefit of those who may be interested in using twisted-pair feeders, the drawings in Fig. 3 show a number of methods of coupling the transmission line to the transmitter. At (a) is a tank circuit,  $L-C$ , tuned to the same frequency as the transmitter and coupled inductively to the output tank. The transmission line is connected across a few turns of  $L$  to step down the r.f. voltage to the right value for maximum power transfer to the antenna. The method of adjusting is a little more complicated than ordinary Zepp tuning but is not actually difficult.

The feeders should be clipped across approximately one-fourth the number of turns in *L* and the circuit adjusted to resonance by means of condenser *C*. The coupling between *L* and the transmitter tank should be loose. Readjust the transmitter tank tuning condenser for minimum plate current and tighten up the coupling until the tube or tubes draw normal plate current. Now readjust the transmitter condenser for minimum plate current; if the plate current dips appreciably at a different setting of the condenser the number of turns included between the feeders is too small. Try an additional turn and repeat the process. When the adjustments are correctly made the value of plate current obtained by increasing the coupling will also be the minimum current obtained by swinging the transmitting tank condenser. Swinging condenser *C* also will cause the plate current to drop on both sides of the resonance setting. The inductance-capacity ratio in *L-C* is not highly important; a 250- $\mu$ fd. condenser with a coil which makes resonance come at about the center of the condenser scale will be about right. An r.f. ammeter may be placed in one of the feeder leads, in which case the adjustments giving maximum feeder current will be correct.

The circuit in (b) eliminates the extra tank circuit and thereby simplifies the adjustments. One feeder wire is clipped to the "cold" end of the tank and the other tapped along the coil until the transmitter draws the desired plate current. This also is true of (c), which shows the same type of connection for a push-pull circuit, in which case the feeders are tapped equidistant from the center-tap. The condensers marked *C*<sub>1</sub> should have rather large capacity — .0005 or more — and may be of the mica type. Their purpose is to insulate the feeders from the plate voltage when series plate feed is used on the transmitter tank. They are not necessary if parallel plate feed is used.

A third feed possibility is to use a coupling coil of a few turns connected directly to the feeders and to vary the coupling between the coil and the transmitter tank until the transmitter draws normal plate current. This will obviate the necessity for the insulating condensers.

The antenna in all cases must be a half wavelength long. The length can be figured quite closely by using the formula

$$\text{Length (feet)} = \frac{468,000}{\text{Freq. in kc.}}$$

The antenna is cut in the center and an insulator inserted as shown in Fig. 3. The ends of the feeders are simply soldered to the two parts of the antenna right at the insulator.

It will be seen that this antenna-feeder system is exactly like the familiar "doublet" receiving antenna. Its effectiveness for receiving is well known; it results from the fact that the antenna

impedance and the feeder impedance are sufficiently well matched to transmit received signals with little loss. It is equally effective as a transmitting antenna for the same reason. The losses with feeder lengths likely to be used by amateur stations can be considered to be negligible at usual frequencies with transmitters of moderate power — that is, for outputs up to a few hundred watts at least. While unsuited to harmonic operation, such an antenna is bound to have many applications. What's more, the same system can be used both for transmitting and receiving by installing a d. p. d. t. switch in the feeder.

## Financial Statement

BY ORDER of the Board of Directors the following statement of the income and expenses of the American Radio Relay League, Inc., for the first quarter of 1933 is published for the information of the membership.

K. B. WARNER, *Secretary*

### STATEMENT OF REVENUE AND EXPENSES FOR THE THREE MONTHS ENDED MARCH 31, 1933

REVENUE			
Advertising sales, QST . . . . .	\$9,633.13		
Newsdealer sales, QST . . . . .	12,216.15		
Handbook sales . . . . .	11,970.25		
Beginners booklet sales . . . . .	491.42		
Membership dues . . . . .	11,688.25		
Membership supplies sales . . . . .	2,419.30		
Interest earned . . . . .	735.99		
Cash discounts earned . . . . .	204.40		
Bad debts recovered . . . . .	132.09		
			\$49,400.98
Deduct:			
Returns and allowances . . . . .	\$5,932.53		
Cash discounts on sales . . . . .	223.96		
Exchange and collection charges . . . . .	49.19		
			\$6,205.68
Less reduction of provision for returns:			
For Handbooks . . . . .	\$1,080.00		
For QST . . . . .	105.99	1,185.99	5,019.69
Net Revenue . . . . .			\$44,471.29
EXPENSES			
Publication expenses, QST . . . . .	\$9,887.91		
Publication expenses, Handbook . . . . .	6,437.53		
Publication expenses, Booklet . . . . .	151.91		
Membership supplies expenses . . . . .	1,170.16		
Salaries . . . . .	16,755.47		
QST forwarding expenses . . . . .	534.45		
Telephone and telegraph . . . . .	344.65		
Postage . . . . .	1,232.26		
Office supplies and general expenses . . . . .	1,395.12		
Rent, light and heat . . . . .	1,048.35		
Traveling expenses . . . . .	442.96		
Provision for depreciation . . . . .	277.57		
Communications Department field expenses . . . . .	186.16		
Headquarters station expenses . . . . .	31.60		
Federal tax on bank checks . . . . .	5.44		
Total expenses . . . . .			39,901.54
Net gain from operations . . . . .			\$4,569.75

# A Simple Tape Recorder for C.W.

**M**ANY of us have wished, at one time or another, that we had a simple and inexpensive tape recording rig for copying c.w. telegraph. It would be useful in "taking down" for permanent record some transmission of historical importance, for instance, or for making a graphical record of our sending so that we might see just what our own "fist" looked like. Unfortunately, however, most of the systems heretofore available have required either a considerable outlay of cash for the necessary equipment or more than ordinary skill and working facilities for making it up. Just recently we had the opportunity of testing a simple and exceptionally effective system that has been developed by Mr. M. A. Noss, of 438 Central Avenue, New Haven, Connecticut. Unlike most systems, it is easily made up, requires no mechanical relays for its operation, nor does it involve the use of a siphon-type pen. The audio-frequency electrical output of the receiver itself does the recording on the tape by an electro-chemical process.

The secret of the system is the use of sensitized tape such that the flow of a small electrical current through the tape causes it to change color. The tape is simply pulled between a pair of electrodes whose points are separated by the paper and which are connected to the output transformer of the receiver. When electrical current flows the tape is discolored and presto!—the dots and dashes of the continental code appear in blue immediately.

As shown in the photograph and sketch, all that is necessary is some sort of mechanism (either electric- or spring-motor driven) to pull the tape through, at a uniform speed which can be adjusted to suit the code speed, and the simple electrode arrangement. In the installation

of the photograph the motive power was supplied by an old phonograph motor of the "wind-up" type and the electrode mounting and guide for the tape was made up of pieces of fiber. The electrodes are pieces of stiff steel about the size of darning needles mounted in the binding posts and having their ends rounded so as not to tear the tape.

## SENSITIZING THE TAPE

The tape is sensitized to show color when exposed to electrical current by soaking it in a solution consisting of one ounce of ferricyanide of

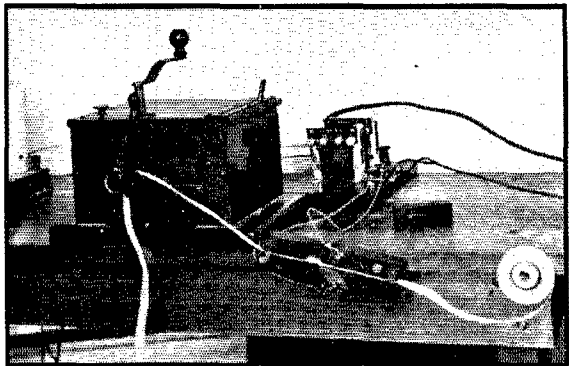

C.W. TRANSMISSION IS COPIED BY FEEDING THE BEAT NOTE OUTPUT OF THE RECEIVER THROUGH A STEP-DOWN TRANSFORMER TO THE PAIR OF ELECTRODES BETWEEN WHICH PASSES THE SENSITIZED TAPE

One type of electrode mounting and tape guide is shown screwed to the edge of the table while a simpler arrangement is on the table at the right. The tape-feed drive is furnished by an old phonograph spring motor in the box at the left.

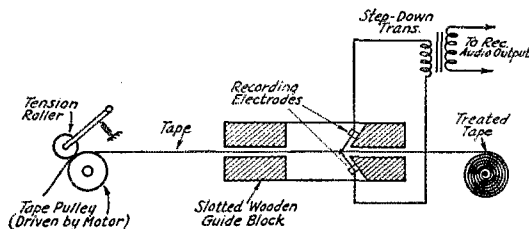

FIG. 1—A SCHEMATIC ILLUSTRATION OF THE SIMPLE MECHANISM USED FOR THE NOSS SYSTEM OF RECORDING

The speed of transmission that can be copied is limited only by the rate at which the tape can be drawn through. Suitable tape is obtainable from firms supplying equipment for telegraph recorders.

potassium and one pound of sal ammoniac in one gallon of water. The tape should be of a rather porous or pulpy type (in preference to the smooth glazed type generally used for ink recording). A number of rolls may be soaked at one time and kept until used in a sealed container such as a fruit jar. The tape must be moist, although not actually "wet," when used for recording. If it should become too dry in storage it may be exposed to moist atmosphere, as by steaming for a few minutes. Mr. Noss reports that treated tape that had been dried out for several months recorded satisfactorily upon remoistening.

In making a tape recording, it is necessary only to tune in the signal (with a pair of 'phones across the output transformer secondary for monitoring) and then adjust the speed of tape travel until satisfactory spacing of the characters is obtained. Since there is no mechanical lag in the circuit, there is no limit

to the code speed which can be copied. All that is necessary is to run the tape fast enough to make the characters legible.

The inventor, Mr. Noss, will welcome comments and suggestions from those who use the system.

### Recording Signals with the Teleplex

NOT long ago the operators of W6FMR were asked to adapt a Master Teleplex to a receiver so code transmissions could be recorded. Since the Teleplex is leased, it was necessary to work out a scheme which would not involve alterations to the machine itself. The idea detailed below has worked out very satisfactorily.

The Teleplex makes use of a vacuum tube relay which is actuated by the conducting prop-

volts on the first audio. The grid bias for tube B was obtained from a 22½-volt battery and controlled by a 50,000-ohm potentiometer. It is necessary to have connections from the plate and filament of tube B to the tape contacts as shown in Fig. 2.

This arrangement has recorded satisfactorily commercial tape and "bug" transmissions up to 45 words per minute. The recordings make good code practice tapes as they are accurately spaced and may be run at any speed desired.

—Fitch, Morton, Rietzke, W6FMR

### Kansas National Guard Station CX7

(Continued from page 16)

dial. The hour hand was lengthened and the minute hand was replaced by a short, wide hand

and rotated over that portion of the dial used by the second hand. A piece of cardboard was slipped over the original dial and the hours laid off on a circle, in black, with the morning schedules arranged, in red, on a circle just inside the circle containing the hours. The afternoon and evening schedules were arranged, in blue, on a circle just outside the hour circle. The call letters of each scheduled station were placed in

the space allotted that station and when in operation the extended hour hand would indicate the amateur being contacted, approximately how much time had elapsed, how much longer the schedule was active and with whom the next schedule would be. The minute hand would show this information to the minute and the second hand, of course, giving it down to the second. The clock functioned perfectly and was a great help in preventing the operators from running over skeds. In fact, it was the official "Camp Time."

When the first camp was over it was only necessary to place a new dial on the clock containing the schedules for the second camp.

### Strays

An insulating paint that will stand 1600 volts per mil is now being made by the Eastern Mabelite Corporation, New York, and sold under the trade name of "Mabelite." The high insulating qualities are attributed to the use of a special chemically-inert pigment which is found only in one deposit in Oklahoma. In addition to its high dielectric strength, the paint made from Mabelite pigment is acid- and alkali-resistant, and is unaffected by heat and light.

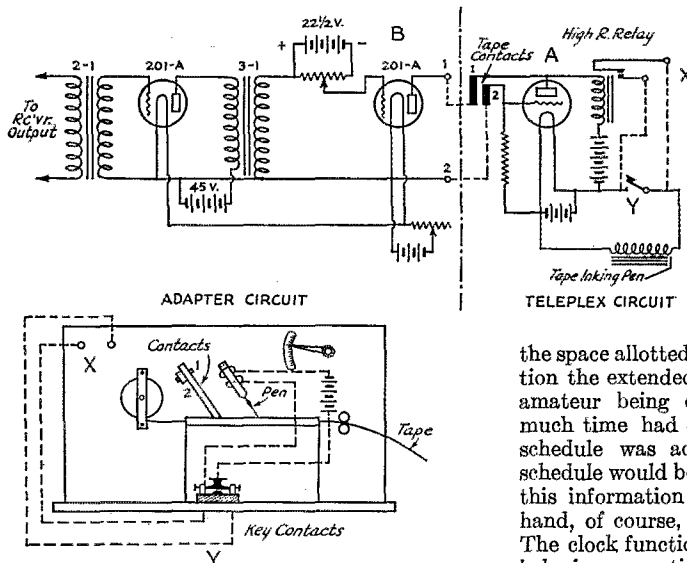

FIG. 2—CIRCUIT FOR RECORDING SIGNALS ON THE TELEPLEX

erties of metallic ink. This relay is used to actuate the inking pen as shown in Fig. 2.

The signal-recording adapter circuit consists of an audio stage transformer coupled to a tube, B, whose grid bias can be varied over a wide range. It is necessary to have the plate-filament resistance of tube B of such value that the vacuum tube relay, A, in the Teleplex, will not operate when no incoming signal is impressed upon tube B. When a signal is impressed on the grid of tube B the resistance of the plate-to-grid circuit of tube A is decreased, allowing current to flow in the plate circuit and actuating the high-resistance relay. Any type tube may be used at B if sufficient bias voltage is available.

We used 201-A's throughout, with 45 to 90



# Annual Meeting of the Board of Directors

By K. B. Warner, Secretary, A.R.R.L.

THE annual meeting of the Board of Directors of the American Radio Relay League was held in Hartford on May 12th. As every amateur knows, this Board is the governing body in organized amateur radio in the United States and Canada, and these annual meetings have an unusual importance in that collected amateur opinion is there analyzed by representatives from all parts of the country, the progress of the League checked up, and new policies made to meet changing conditions. It was in several ways a notable meeting. Unusual harmony prevailed, the directors finding amateur sentiment pretty much the same all over the country on this year's problems, with the result that every action taken was by a unanimous vote. And for the first time since the League "went democratic" in 1923, the Board concluded its labors in a single long day's sessions.

Every director was present except Vice-President Stewart, who lay ill in South Carolina, and Director Culver of the Pacific Division who, through no fault of his own, was unable to get to the meeting in time. It is greatly to be regretted that our very energetic Pacific Division had no representation. The transportation properties for which Mr. Culver is an engineer experienced, less than a week before the Board meeting, a fire that did damage of several million dollars. For some days it seemed hopeless for him to attend the meeting. Eventually he was able to depart from the Coast by air, on a schedule that should have brought him to the meeting late in the day. But adverse weather had set in, the flying service from Oakland east was canceled. The service was still running out of Los Angeles, however, so he flew there and took off for the east, but only to experience further delays and a canceling of schedules both at Wichita and at Pittsburgh, finally arriving at Hartford just a few minutes before noon on the day after the meeting. He had a few hours with us at headquarters and was then obliged to hurry back to his business. His report, which he had mailed by air when it seemed impossible to come to the meeting, was delayed apparently by the same weather conditions and did not reach West Hartford until the first of the following week. Tough luck all around.

First the directors heard the officers report on their stewardship of League affairs in the past year, with their recommendations for the future. Then each director in turn reported to all of the others on the points of view prevailing in his area. These preliminaries formed a foundation of solid information on which the Board then proceeded to the work in hand.

Changing conditions in amateur radio necessitate changes from time to time in the governing regulations of the government. Perhaps the most important of the Board's decisions related to the recommendations to be made to the Federal Radio Commission for changes in its amateur regulations.

First, as has always been the case in recent years, there was the question of 'phone. A year ago the Board instructed the Communications Manager to make a survey of the relative 'phone and c.w. occupancy in the 1715-2000 kc. band. In this band it is both possible and desirable that the sub-division between 'phone and telegraphy be proportional to the relative occupancy. With the data before it, it was apparent to the Board that the 'phone allocation should be increased, and it unanimously voted to request the Commission to expand the 'phone sub-band to embrace the 200 kilocycles from 1800 to 2000 kc. Although a couple of the directors reported sentiment in their divisions in favor of widening the 3900-4000 'phone allocation, all the rest of the country was vigorously opposed to any changes in either this or the 14-mc. band, and the Board decided to make no recommendations on these bands. Our 28-mc. band, it will be remembered, has never been opened to 'phone. Amateur work in these ultra-high-frequency bands has shown that the quickest development can be attained by permitting 'phone operation. Since at certain points in the solar cycle the 28-mc. band performs similarly to the 14-mc. band and is good for extreme DX, it was not felt that all of it should be open to telephony. But a start has been made, by a unanimous vote of the Board requesting the Commission to open from 28,000 to 28,500 kc. to amateur telephony — which will be welcome news to the u.h.f. crowd.

Undoubtedly the most radical and forward-stepping act of the Board related to amateur power supplies. The American Radio Relay League has gone d.c.! The expressions of opinion that you fellows have given your directors show that the amateurs in every division of the League are in favor of having a regulation that will make compulsory the use of direct current on all stages of a transmitter, doing away with alternating current on amplifier stages and the superimposing of intentional tone-modulation on d.c. signals. This is not nearly as drastic a step as it sounds, because such changes always lag behind our ability to prepare for them, and it has been the general sentiment of amateur radio for over a year now that we are ready for d.c. signals as a needed improvement in the operating ether — as the best

single thing that can be done to minimize broad and unstable signals with their selfish interference. Again by unanimous vote, then, the Board requested the Commission to amend the regulations for wavelengths above 20 meters so that they call for a simple specification of adequately filtered direct-current plate supply and prohibit the wilful application of tone modulation. It is not intended that these specifications apply to "5 & 10", where simple experimental equipment still requires a modulated signal for successful communication.

The Board examined at length the tendency to centralize the examination of radio operators at Washington by mail, with a general lowering of the bars both on technical information and code knowledge. It vigorously opposed all of this and established the League as calling for more careful personal examination of amateur applicants, both as to technique and operating ability. The absence of any adequate enforcement of the regulations was similarly examined and a plan adopted to endeavor to secure the Commission's sanction for an amateur self-policing scheme. There will be further reports in *QST* on these subjects as news develops.

The Board took a careful look into our traffic handling business and its status, passed a cordial vote of thanks to the Standard Frequency Stations for their valiant assistance, disposed quickly of several questions of internal procedure. After a quite careful examination of the facts, the Board decided to take no action either on a proposal to classify members by confining the voting privilege in the League to the holders of operator licenses, or in increasing the amount of membership dues. The headquarters technical staff was given a large order on behalf of the 'phone men when the Board requested it to investigate the feasibility of applying to amateur radiotelephony methods involving the suppression of one side-band or of the carrier and one side-band! Many other subjects were discussed and, although without formal action to record in minutes, resulted in a profitable interchange of ideas.

*It must particularly be noted that the matters hereinabove reported, relating to changes in F.R.C. regulations, have not yet been enacted by that body. They are recommendations from the League's Board of Directors. Meanwhile there is no change in amateur regulations. As always, prompt report will be made in QST and by broadcasts of any changes enacted by the Commission.*

The minutes of the meeting follow.

MINUTES OF ANNUAL MEETING, BOARD OF DIRECTORS, AMERICAN RADIO RELAY LEAGUE MAY 12, 1933

In compliance with the constitution and pursuant to notice, the Board of Directors of the American Radio Relay League, Inc., met in regular annual meeting at the Hartford Club, Hartford, Conn., on May 12, 1933. The meeting was called to order at 10:05 a.m., D.S.T., by President Maxim. At opening roll-call there were present

Directors Maxim, Andrews, Bailey, Caveness, Corlett, Fuld, Gibbons, Hagler, Hill, Kerr, Reid, Windom and Woodruff. Absent, Directors Culver, Lindsmith and Stewart. There were also present Secretary Warner, Treasurer Hebert, Communications Manager Handy, General Counsel Segal and Assistant Secretary Budlong.

On motion of Mr. Bailey, it was unanimously VOTED that, without reading, the minutes of the last meeting of the Board are approved in the form in which they were issued by the Secretary.

The reports of the President, Secretary, Treasurer, Communications Manager, General Counsel and Fieldman were read by those officials, respectively. The Chairman also read a communication from Vice-President Stewart, ill and unable to attend the meeting. On motion of Mr. Corlett, it was unanimously VOTED to accept all reports as read and place them on file.

Director Lindsmith entered the meeting at 10:40 a.m., during the reading of the reports.

On motion of Mr. Windom, it was unanimously VOTED that all acts performed and all things done by the Executive Committee since the last meeting of the Board, and by it reported to the Board, are ratified and confirmed by the Board as the actions of the Board.

Mr. Reid presented his report as Canadian General Manager. In turn, every division director present rendered a report on conditions in his division. During the presentation of the directors' reports the Board, on motion of Mr. Kerr, recessed for luncheon at 12:46 p.m., reconvening with the same attendance at 2:14 p.m.

On motion of Mr. Windom, it was unanimously VOTED that the sum of twenty-eight hundred dollars (\$2800) is hereby appropriated from the surplus of the League, as of this date, for the purpose of defraying the expenses of holding this meeting of the Board of Directors, any unexpended remainder of this sum to be restored to surplus.

The Chairman announced the receipt of a communication from a magazine, *R9*, Hollywood, Calif., transmitting what was called a "report" and a series of recommendations. The Secretary read the letter. Moved, by Mr. Bailey, that this letter and all matters pertaining thereto be placed on the table. After discussion, moved, by Mr. Corlett, to amend the motion to provide for tabling these communications until the arrival of Director Culver. But the amendment was rejected. The question of adoption being put, the vote was unanimously in the affirmative. So the communications were tabled.

On the question of widening the sub-allocation for ordinary radiotelephony in the 1715-2000-ke. band, after extended round-table discussion, on motion of Mr. Kerr, it was unanimously VOTED that the Federal Radio Commission is requested to amend its regulations to widen the 'phone sub-band to read 1800 ke. to 2000 ke.

On the question of discontinuing the publication in "QST" of the directory of affiliated clubs, after round-table discussion, on motion of Mr. Corlett, it was unanimously VOTED that the preparation of affiliated-club data be continued and be revised as often as necessary, that copies of the list be furnished directors and, if the expense can be afforded, to the affiliated clubs themselves; that the availability without cost of copies of this list be advertised in every issue of "QST"; but that publication in *QST* of the list itself be discontinued.

On the question of Amending Article II of the Constitution as proposed by Mr. Andrews, Mr. Andrews withdrew the proposal.

On the Secretary's proposal to increase the membership dues, after round-table discussion, on motion of Mr. Bailey, it was unanimously VOTED that there be no increase in membership dues.

On the Communications Manager's recommendation regarding membership-card distribution, moved, by Mr. Corlett, that the distribution of membership lists by card method be discontinued. Moved, by Mr. Hill, to amend the motion to provide that the Communications Manager prepare mimeographed lists of new members quarterly; but there was no second, so the motion for amendment failed. The question then being on the adoption of the original motion, the same was unanimously adopted.

## Standard Frequency Transmissions

On the subject of show stations, after discussion, on motion of Mr. Corlett, it was unanimously VOTED that the Executive Committee is given full authority to deal with the matter of show stations.

On motion of Mr. Kerr, it was unanimously VOTED that the thanks and appreciation of the A.R.R.L. are extended to the owners and staffs of the A.R.R.L. Standard Frequency Stations for their valuable work.

On the question of operator licensing regulations, after extended discussion, by ruling of the Chair, without objection, the further negotiation of this matter was placed in the hands of the General Counsel and the Secretary, after the Board had unanimously expressed itself as demanding a continuation of code knowledge and code examination by all amateur applicants, personal examinations rather than mail examinations, and a higher standard of qualifications.

On the question of amateur power supplies, after discussion, on motion of Mr. Bailey, it was unanimously VOTED that the Federal Radio Commission is requested to amend its Regulation 382 by deleting certain portions thereof so that it reads: "Licensees of amateur stations shall use adequately filtered direct-current power supply for the transmitting equipment to minimize frequency modulation and prevent the emission of broad signals," it being understood that this applies only to the amateur frequency bands below 14,400 kc. and not to amateur frequencies above 28,000 kc.

The Board recessed for dinner at 6:36 p.m., reassembling with the same attendance at 8:32 p.m.

On the question of opening a ten-meter band for amateur radiotelephony, on motion of Mr. Fuld, it was unanimously VOTED that the Federal Radio Commission is asked to open the sub-band 28,000 kc. to 28,500 kc. to unrestricted amateur radiotelephony, type A-3 emission.

On motion of Mr. Fuld, it was unanimously VOTED that the technical staff of "QST" is instructed to investigate the feasibility, and, if feasible, is instructed to undertake the development at reasonable prices, of apparatus and methods for single-side-band and carrierless phone transmission.

Moved, by Mr. Fuld, that we recommend to the Federal Radio Commission that the unlimited phone privilege be given only after two years experience under license. But there was no second, and Mr. Fuld withdrew the motion.

Moved, by Mr. Fuld, that the portion of the Communications Department report in "QST" which has to do with the individual amateur activities be discontinued, and that said space be devoted to discussion of League policies so far as they may safely be discussed in print, and the encouraging, fostering and aiding of affiliated clubs. There was general discussion, but no second, so the motion failed.

On motion of Mr. Fuld, it was unanimously VOTED that the Board instructs the Secretary and General Counsel to consider and adopt a plan to be submitted to the Federal Radio Commission or its proper division, whereby the policing of the amateur bands shall be assumed by the League and its local appointees under the sanction of the Commission and with specific powers to be conferred by that body.

On motion of Mr. Corlett, it was unanimously VOTED that a telegram be sent to Vice-President Stewart expressing the Board's sympathy in his illness and its regret at his inability to be present.

On motion of Mr. Lindesmith, it was unanimously VOTED that the League recommends to the Federal Radio Commission that no form of wilful modulation for radiotelegraph transmission be permitted on amateur frequencies below 14,400 kc.

During its several sessions the Board, without formal action, discussed the widening of the amateur bonds, protection of traffic rights, automobile ordinances, call-book publication, higher standards for club affiliation, compulsory crystal-control, Mexican participation in A.R.R.L.

There being no further business, the Board, on motion of Mr. Bailey, adjourned at 10:16 p.m.

K. B. WARNER, Secretary.

Date	Schedule	Station	Date	Schedule	Station
July 5,	B	W1XP	Aug. 4,	B	W9XAN
	C	W9XAN		A	W6XX
	B	W9XAN		B	W1XP
July 7,	A	W6XX	Aug. 9,	BB	W9XAN
	B	W1XP		BB	W6XIK
July 12,	BB	W9XAN	Aug. 11,	A	W9XAN
	BB	W6XX		Aug. 12,	BX
July 14,	A	W9XAN	Aug. 13,	C	W6XX
	BX	W6XX	Aug. 18,	A	W6XX
July 15,	C	W6XX	Aug. 20,	C	W1XP
July 16,	A	W6XX	Aug. 23,	A	W1XP
July 21,	A	W6XX	Aug. 25,	B	W9XAN
July 23,	C	W1XP	Aug. 26,	B	W1XP
July 26,	A	W1XP	Aug. 30,	BB	W1XP
July 28,	B	W9XAN		C	W9XAN
B	W6XX				
Aug. 2,	BB	W1XP			
	C	W9XAN			

### STANDARD FREQUENCY SCHEDULES

Time (p.m.)	Evening Sched. and Freq. (kc.)		Time (p.m.)	Afternoon Sched. and Freq. (kc.)	
	A	B		BB	C
8:00	3500	7000	4:00	7000	14,000
8:08	3600	7100	4:08	7100	14,100
8:16	3700	7200	4:16	7200	14,200
8:24	3800	7300	4:24	7300	14,300
8:32	3900		4:32		14,400
8:40	4000				

Time (a.m.)	Sched. & Freq. (kc.) BX
6:00	7000
6:08	7100
6:16	7200
6:24	7300

The time specified in the schedules is local standard time at the transmitting station. W1XP uses Eastern Standard Time, W9XAN, Central Standard Time, and W6XX, Pacific Standard Time.

### TRANSMITTING PROCEDURE

The time allotted to each transmission is 8 minutes, divided as follows:

- 2 minutes — QST QST QST de (station call letters).
- 3 minutes — Characteristic letter of station followed by call letters and statement of frequency. The characteristic letter of W1XP is "G"; that of W9XAN is "O"; and that of W6XX is "M."

1 minute — Statement of frequency in kilocycles and announcement of next frequency.

2 minutes — Time allowed to change to next frequency. W1XP: Massachusetts Institute of Technology, Round Hill Research, South Dartmouth, Mass., Henry G. Houghton in charge.

W9XAN: Elgin Observatory, Elgin National Watch Company, Elgin, Ill., Frank D. Urie in charge.

W6XX: Don Lee Broadcasting System, Los Angeles, Calif., Harold Peery in charge.

### WWV 5000-KC. TRANSMISSION

The 5000-kc. transmissions of the Bureau of Standards station, WWV, are given every Tuesday continuously from 12:00 noon to 2:00 p.m., and from 10:00 p.m. to midnight, E.S.T. The accuracy of these transmissions is to better than 1 cycle (one in five million).

— J. J. L.

# A Shack on Wheels

Portable WIFWL Travels Throughout U.S.A.

By Philip S. Rand, WIDBM-WIFWL\*

**I**N 1929 the writer was employed by the New York, Rio, & Buenos Aires Air Line, an air transport line operating a fleet of planes from New York to South America, and stationed in Miami, Florida.

During my stay there I had occasion to see a very interesting trailer that was being used by the Pan American Airways. Upon inquiry I discovered that it was built in a small town just outside of Miami by Glenn Curtiss of airplane fame. In the next few days I managed to pay the factory a visit and find out just how they were built. I saw the possibility of a shack on wheels, and inasmuch as I did not possess the necessary two or three thousand dollars, I decided I would have to build my own. For the benefit of those who should like to build one, too, I shall give a few of the constructional details.

The first requisite is an old model T Ford axle, either front or rear, front being preferred however. The next thing is to obtain a number of sound 2 by 3's and two long 2 by 6's for the frame and several sheets of Insulite wall board for the sides and roof. The outside is covered with a good grade of imitation leather similar to that used on auto tops.

The arrangement of the interior is left to the builder although the layout used at WIDBM is given as an example. A number of very interesting interiors may be drawn up if the builder will use his imagination a little and design his shack to suit his particular needs.

One of the most important considerations in designing a trailer of this sort is the weight. The trailer completely loaded must be light enough so the car that is to be used can tow it easily up grades; it must be high enough to give full head room inside and yet not be top-heavy. All heavy weight must be kept low, near the axle, and evenly distributed on both sides. The more powerful the tow car, the larger and more comfortable may be the "shack." A car with four speeds ahead and silent second gear is especially desirable.

I shall not attempt to tell the builder how long to cut the 2 by 3's or how many nails and screws

to use but rather to give the general idea so that the builder may go ahead according to his own requirements.

The first thing to do is to build the chassis out of some husky pieces of 2 by 6 something like Fig. 2, using plenty of long lag screws and bolts — the chassis must be strong to stand bumpy roads.

The chassis must be laid out so that you can attach whatever kind of axle and springs are to be used. If a Ford axle is used, a crosspiece to which to attach the spring will be required. The wishbone or torque rods must be made fast to the frame. An axle with springs running lengthwise will give more headroom inside.

The general framework is now built on the chassis along the lines indicated in Fig. 2, being sure to put in a corner brace or angle iron at every corner as the strain is terrific at high speeds. Fig. 1 shows the general idea for the sliding windows. Portholes may be used, but the windows are to be preferred, especially if the trailer is to be used during warm weather.

After the framework is completed it is time to put on the wallboard. This may be Celotex,

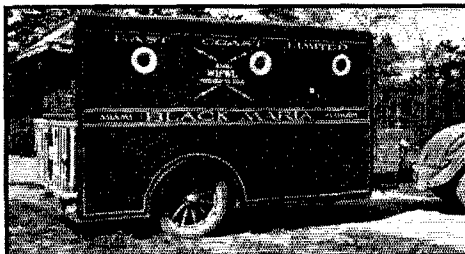

WIFWL—"BLACK MARIA"

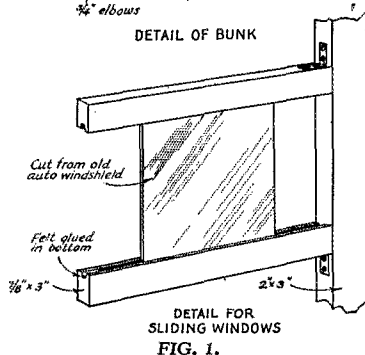
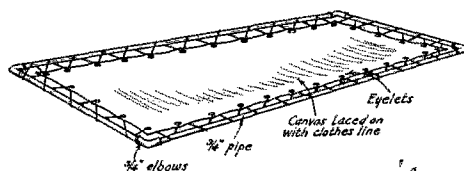

\* North Falmouth, Mass.

Insulite, Masonite, or any other material of that nature. The roof construction is similar to that used on autos. After the crosspieces have been cut to the shape wanted for the roof, laths are nailed on lengthwise quite close together and the whole thing covered with several layers of burlap. The final covering is of imitation leather. The sub-layers of burlap make a smoother looking job, and help the leather covering from wearing through quickly.

The whole thing may now be covered with imitation leather, as is *Black Maria*. If Masonite has been used, it may be Ducoed to match the car that will tow it.

The inside can be completed now if the plans have been decided upon. Space should be left under the bunks for suitcases and luggage. Hooks may be put in the pointed bow to hang up clothes, or it could have several shelves.

The bunks can be made out of  $\frac{3}{4}$ -inch pipe similar to those used on shipboard (see Fig. 1), to fit the space available. The upper berths are lashed to the ceiling in the daytime.

The stove is a two-burner gasoline affair, while the sink is made by lining a box with copper and soldering up the joints. Don't forget the drain. The water tank is a ten-gallon gas tank standing on end and lashed in place, with a water faucet soldered to the bottom over the sink. The ice box is made by lining a large box with several thicknesses of Insulite, with zinc in the bottom with a drain. There should be a railing around the shelves of the food locker so that too much won't bounce on the floor when under way.

Dome lights, running lights and a tail light should be provided together with a horn button for signaling the driver. A five-prong socket and tube base make a convenient plug-in arrangement for your electric cable from the car to trailer. Wire the running lights with the car's headlights and they will operate with the switch on the steering wheel.

A swell indoor antenna may be put inside the top before putting on the leather. Small stand-offs take the transmitting feeders out in the usual fashion, while bamboo fish poles are used to support the antenna if no higher support can be found. A five-meter antenna is supported on the bow by three stand-offs. This is a telescoping affair of  $\frac{1}{2}$ -inch copper pipe which stretches up to 8'.

Any type of transmitting equipment may be used that is portable, or a rack and panel job

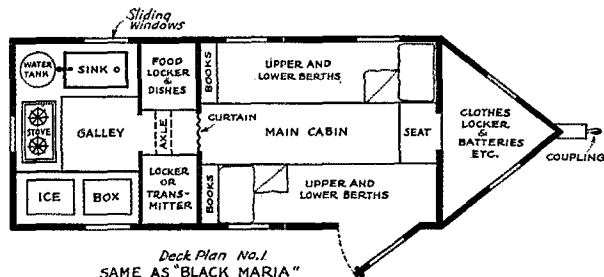
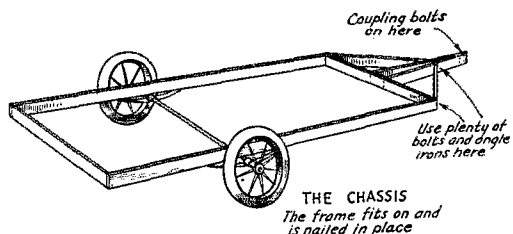

Deck Plan No. 1  
SAME AS "BLACK MARIA"  
Except sliding windows are  
shown instead of portholes

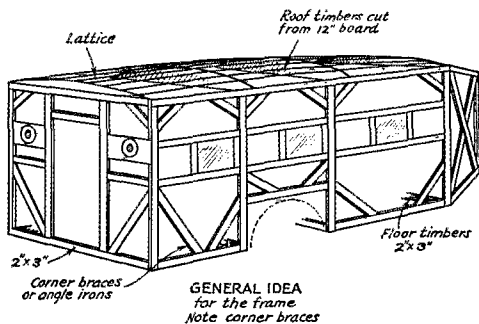

FIG. 2.

may be built right in during the construction. The 160- and 80-meter sets in *Black Maria* consist of two 33's in parallel crystal controlled and coupled directly to the antenna, running from a set of "B" batteries. The five-meter job has two 12-A's in push-pull modulated by two 33's, also run by "B" batteries.

The *Black Maria* cruises very comfortably with a party of four. The tow car is a Chrysler 77 convertible coupe which at times has attained a speed of 70 miles per hour with the 1500-lb. shack in tow. I have slept several nights in the trailer while under way on a long trip and can honestly say that I slept better than when on a railroad train.

The coupling that fastens the trailer to the car is a homemade affair, but I should recommend that anyone building a trailer purchase any one of a number of good couplings that are on the market. And one more thing; be sure you have enough road clearance so you can navigate an occasional detour.

# Economical Use of a Milliammeter

## Using One Meter for the Three Most Important Transmitter Measurements

By William G. Pierpont, W9BLK-HPU\*

**I**N THE amateur's transmitter it is common to have three types of meters: The d.c. meter for milliamperes and volts, the a.c. meter for filament voltage, and the radio frequency ammeter for the antenna current. Articles have already appeared in *QST* on using one milliammeter for measuring all the plate and grid currents and the voltages on the plates of the tubes, by using jacks and plugs and various shunts and series resistors. In this article the writer will ex-

can be made by using one of the Jewell or Weston low-range voltmeters, such as used for measuring filament voltage on the old battery type receivers. The case must be removed and the series resistor or resistors removed. The small meters used on the old Radiola receivers make excellent milliammeters if of the type mentioned. The movement is about 0-8 or 0-10 mils full scale.

### THE GRID OR PLATE MILLIAMMETER

The maximum reading of the low-range milliammeter can be extended quite easily for reading plate and grid currents. Shunts for the meter are connected as shown in Fig. 1A. The lower the resistance of the shunt, the greater will be the full-scale current reading. The shunts may be wound around a small spool after the correct length of wire is determined. The range of the shunted meter may be found by comparison with a meter

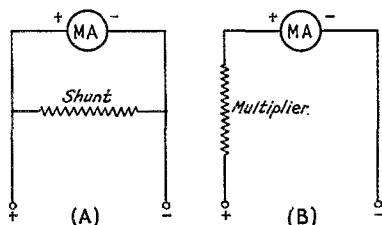

FIG. 1 — SHUNTS AND MULTIPLIERS ADAPT THE LOW-RANGE MILLIAMMETER FOR CURRENT AND VOLTAGE MEASUREMENTS

The shunt resistor in (A) extends the range of current measurement. The series resistor in (B) will make a wide range of voltage measurements possible with suitable choice of values.

plain how one meter may be used for measuring plate or grid current, plate or grid voltage, a.c. filament and line voltage, and radio frequency antenna current.

The meter used for all measurements is a d.c. milliammeter having a range of 0-10 or 0-15

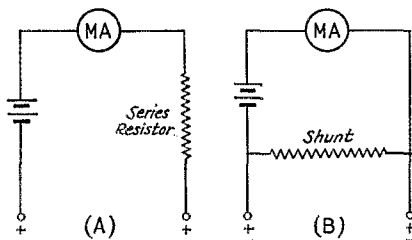

FIG. 2 — USING A COPPER-OXIDE DISC RECTIFIER TO CONVERT THE D.C. MILLIAMMETER TO A.C. MEASUREMENTS

Connections for measuring voltage are shown at (A), for measuring current at (B).

milliamperes. This meter should be of the Weston or Jewell type or one having the same type of movement. If you do not already have one, one

\* 5440 East Douglas Ave., Wichita, Kansas.

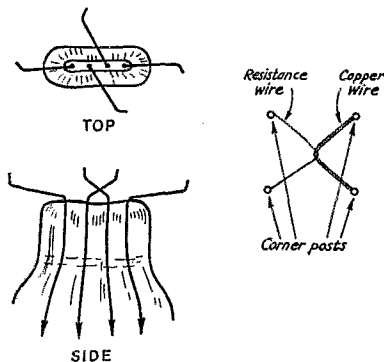

FIG. 3 — HOW THE R.F. THERMOCOUPLE IS MADE

The support is the glass stem of an old tube, preferably of the four-prong type. The grid, filament and plate wires are cut off and bent as shown to form the diagonals of a square. The wires forming the couple are soldered to the points of the square as shown at the right, being hooked together as shown.

of reliable make. If the resistance of the milliammeter is known, the shunt resistance needed for any desired range can be found from the following formula:

$$R_s = \frac{R_m}{N - 1}$$

where  $R_s$  is the required shunt resistance,  $R_m$  is the resistance of the meter, and  $N$  is the scale multiplier; i.e., if a 0-10 mil scale is to be extended to 150 milliamperes  $N$  is 15, etc.

### THE D.C. VOLTMETER

Plate or grid voltage may be measured by fitting the meter with series resistors or "multipliers" of the right size and then calibrated by comparison with a standard meter. By using several large resistors in series plate voltages up to 5000 volts may be measured. However, care must be taken that the resistors have well-insulated

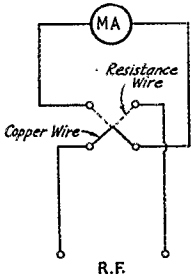

FIG. 4—R. F. MEASUREMENTS USING THE THERMOCOUPLE AND D.C. MILLIAMMETER

terminals, for should one of the resistors become shorted the meter will be ruined. The series resistors also must be capable of carrying the full-scale current taken by the milliammeter. Fig. 1B shows the connections for d.c. voltage measurements. The size of the series resistor is found by experiment or from the following formula:

$$R = \frac{E \times 1000}{I}$$

where  $R$  is the value of the series or multiplier resistor in ohms,  $E$  is the maximum voltage to be measured, and  $I$  is the full-scale reading of the meter in milliamperes.

### THE A.C. VOLTMETER

When the d.c. milliammeter is fitted with a few rectifier discs and a series resistor of the right value, we have a voltmeter for measuring the voltage on the line, or with another series resistor we may measure the filament voltage. Even high voltages may be measured, provided the series resistor is large enough. See Fig. 2A for details.<sup>1</sup>

If the low-range a.c. voltmeter is connected across the output of a receiver or speech amplifier the output may be measured. The principle is the same as with meters made especially for the purpose.

### THE A.C. MILLIAMMETER

This meter is not often used by amateurs, but it is very handy in some types of work. The milliammeter is fitted with the disc rectifier as for

<sup>1</sup> Since the direct current through the meter will depend upon the characteristics of the rectifier, specific values for series resistors and shunts for a.c. readings cannot be given but must be determined by experiment. The meter should be calibrated against a regular a.c. meter of suitable range unless comparative measurements only are wanted.—  
ERROR.

the a.c. voltmeter but shunts are used instead of series resistors. Fig. 3B shows the connections.

### THE RADIO FREQUENCY AMMETER

Radio frequency ammeters are expensive, but it is surprising how simply they can be constructed in the shack. The thermocouple is the heart of the r.f. ammeter. It is easy and cheap to build since it usually can be made from scraps of wire left over from other work.

The thermocouple is constructed as follows: Take an old tube of the 01-A or similar type (it may be burnt out), carefully break the glass envelope surrounding the elements, but do not allow the glass stem to be cracked or broken, or the elements to be bent very much while breaking. Cut the filament support wires — not the ones which go through the stem to the tube base connections — close to the stem. Cut the plate, grid and filament wires off one-half inch above the top of the stem. These are the wires which go to the connections in the prongs. Other wires, such as extra wires which support the plate and grid on the other side, are cut close to the stem. Bend the four wires remaining above the stem so that the tip of each forms one corner of a square one-half inch on a side, as shown in Fig. 3. They are bent slanting so that the corners are above the level of the top of the stem.

Now take a piece of resistance wire, about No. 28 B. & S. gauge — may be of nickel, nichrome, constantin, or some of the wire from the grid of the old tube — and solder one end to one of the wires forming the corner of the square. The other end of the resistance wire is soldered to the next adjacent corner wire, so that the wire forms a "V" with the point or apex of the "V" in the center of the square.

Next take a piece of bare copper wire about the same size and length as the resistance wire. Solder one end of it to one of the remaining wires of the square. Pass the free end of the copper wire through the top of the "V" and out through the bottom, and then to the remaining corner wire. Before soldering it to the corner wire pull it tight, so that both the resistance wire and the copper wire are under tension, then solder to the corner wire.

The couple is now complete and may be used as it is, mounting in a regular tube socket. Alternatively, the base may be carefully removed and the glass stem cut off about one-half inch from the pressed end which holds the electrodes, and the assembly mounted in a small box. Do not allow the pressed portion to break or crack as operation of the couple will be impaired.

Fig. 4 shows the method of connecting the couple to the milliammeter. Several couples may be made to give as many ranges as may be desired. No calibration is necessary as comparative measurements are sufficient. However, the meter

(Continued on page 36)

# The Governors'-President Relay

**M**ESSAGES from thirty-five states (governors) and three territories to the President on his inaugural day were handled by amateur radio and delivered by the Washington Radio Club following the inauguration. The advance arrangements were as outlined in February *QST*. Stations were designated by A.R.R.L. Section Communications Managers in the different states of the Union to originate the messages, starting at 5 p.m. E.S.T. on March third. For the next twenty-four hours the air was combed thoroughly by the member-operators of the Washington Radio Club in organized fashion to collect every message started. All who relayed these messages promptly and accurately may be proud of their part on this significant occasion. Amateur radio again demonstrated its usefulness not only as a means for communication for this event but also its potentialities in case of any national emergency. Messages from distant possessions as well as those from the state capitols were all smoothly collected into the common message-center formed by member-stations of the Washington Radio Club.

W3CXL, W3LA, W3BWT, W3ASO and W3CXM handled the bulk of this incoming traffic. W3BUP, W3NR, W3BVG, W3ZD, W3APJ, W3ADQ and W3ZY snagged "one state" each. The committee handling the relay in Washington (W3CDQ-W3BWT-W3CAB-W3EI) designated W3BWT to act as key station. Besides "ed," "ld" and "cj," W3CDQ, W3ASE, W3DK and W3CHC were at W3BWT. All incoming messages were telephoned to this station on receipt and states checked off a master list so the names of missing states could be supplied at a glance on request. W3AAD and W9BNF worked the key the whole 24 hours at W3LA. W3IE shared the watch at W3NR. The group of Washington stations was carefully organized, every band covered, and a continuous watch maintained for messages. No messages were received on 7-mc. or 1.7-mc. bands although some were relayed on those frequencies. The California message arrived at W3APJ via 14 mc. and all others were received on 3.5 mc. W3ADQ and W3ZY got the Massachusetts and the Georgia messages on 3900-kc. 'phone. The Michigan message was relayed via several different frequency bands. W3BEJ and W3OZ covered

the 1.7-mc. band; W3CIC and W3CYP worked on 3.5 mc.; W3WU, W3CDQ, W3IL, W3EI and W3AWS worked on 7 mc. and W3LX on both 7 and 14 mc. for the duration of the relay. Special mention is due C. A. Briggs, W3CAB, for his efforts to secure an audience with the President for delivery of the messages, and Miss E. M. Zandonini, W3CDQ, deserves similar mention for her work on the relatively tremendous task of typing all incoming messages. With the messages was delivered a paper covering the entire story of the relay, the messages, the history of the A.R.R.L. and its functionings.

The Washington Radio Clubs achieved results far beyond expectations. Its stations and operators spent many hours of diligent tuning and work in large part responsible for the fine job that was put over to go down in history to the credit of the amateur. Those were "real" messages, and they were heartily appreciated. The letter from "F. D. R." presented with this article speaks for itself.

Congratulations and thanks are extended to all who took a constructive part in this activity, and especially to the operators

who sent us copies of their messages making the following full report possible. The routes given below show how the messages travelled and indicate the stations deserving laurels in this work. Eleven of the messages came direct to Washington from state capitols, the remainder being relayed one or several times.

— F. E. H.

## Message Routings

ARIZONA: (Svc. msg.) W6FZQ — W9LKZ — ???  
 ARKANSAS: W5ARP — W5BMI — W3CXL (Ar. 9.37 p.m. 3/3)  
 CALIFORNIA: (1) W6AHN — W6BYB — W3APJ (Ar. 6.19 p.m. 3/3) (2) W6AHN — W6CIS — W6UO — W9ESA — W9KG — W9FUT — W3OK — W3CXM (Ar. 2.35 a.m. 3/4) (3) W6AHN — W6DVE — W6DJS — W6EDZ — W9GNK — W9GFS — W9CKG — W3PP — W8YA — ???  
 CONNECTICUT: W1AFB — W3LA (Ar. 6.07 p.m. 3/3)  
 GEORGIA: (1) W4KU (fone) — W4ZZAN — W3ZY (fone) (Ar. 2.24 a.m. 3/4) (2) W4KU (fone) — W3AQT (opr. W3BZV) — W9EDW — W3ZY 4.10 a.m. 3/4  
 ILLINOIS: W9BNI (W9FKO opr.) — W4JR — W3BWT (Ar. 10.45 p.m. 3/3)  
 IOWA (From Iowa radio amateurs): W9HUY — W9ACL — W3CXM — W3ASO (Ar. 10.20 p.m. 3/3)  
 KANSAS: W9DEB — W9FLG — W5BMI — W3CXL (Ar. 11.40 p.m. 3/3)

## THE WHITE HOUSE WASHINGTON

March 21, 1933.

My dear Mr. Corderman:

*I wish to thank you and your fellow members of the Washington Radio Club, as well as all members of The American Radio Relay League who participated, for your services in transmitting to me the "Governors-to-President Relay Messages" originating at state capitols in connection with the inaugural proceedings. I derived a great deal of pleasure from my perusal of these messages.*

*You are to be complimented on having and maintaining at such high state of efficiency an organization composed solely of amateurs in the radio field.*

Very sincerely yours,

FRANKLIN D. ROOSEVELT

Roy C. Corderman, Esq.,  
4401 Leland Street,  
Chevy Chase, Maryland.



KENTUCKY: W9OX — W1LT — W3BUP (Ar. 7.35 p.m. 3/3)

MAINE (To WRC, no sig.): W1CDX — W1CRP — W2WP — W3CXL (Ar. 6.22 p.m. 3/3)

MARYLAND: W3ADO — W3NR (Ar. 5.06 p.m. 3/3)

MASSACHUSETTS: (1) W1SL (fone) — W3ADQ (Ar. 6.45 a.m. 3/4) (2) W1ASI — W8EIK

MICHIGAN: W8BWR (56 mc.) — W8JO (3.5 mc.) — W8BGY (1.7 mc.) — W8PP — W8BBH — W3OK — W3CXM (Ar. 7.30 p.m. 3/3)

MINNESOTA: W9BBL — W9BN — W3CXL (Ar. 7.55 p.m. 3/3)

MISSOURI: (W9EYG) W9FTA — W8UW — W3CXL (Ar. 7.35 p.m. 3/3)

MONTANA: (1) W7ASQ — W9ESA — W9JNV — W3CXL (Ar. 10.15 p.m. 3/3) (2) W7ASQ — W9ESA — W9FHV — W9FUT — W8BBH — W3OK — W3CXM (Ar. 10.55 p.m. 3/3)

NEBRASKA: (1) W9HYR — W9KUM — W3ZD (Ar. 12.50 a.m. 3/4) (2) W9HYR was copied by VE3GT — W3LA (Ar. 12.30 a.m. 3/4)

NEVADA: (1) W6UO — W9ESA — W9KG — W9FUT — W4JR — W3BWT (Ar. 1.15 a.m. 3/4) (2) W6UO — ? — W9ACL — W3LA (Ar. 4.30 a.m. 3/4) (3) W6ATN (fone) — W4PW — ???

NEW HAMPSHIRE: W1DNC — W2DQK — W3LA (Ar. 8.25 p.m. 3/3)

NEW JERSEY: (W3CFT) W3ZI — W3LA (Ar. 6.01 p.m. 3/3)

NEW MEXICO: W5CJP — W5AWU — W8IHU (and also VE2GD) — W1BCX — W1BWY — W1FNW — W1DCF — W3QN — W3BNN (Mar. 6) — W3NT — W3CXL (Mar. 7)

NEW YORK: W2ENC — W3BWT (Ar. 5.59 p.m. 3/3)

NORTH CAROLINA (for the Gov.): W4DW — W3BVG (Ar. 6.32 p.m. 3/3)

NORTH DAKOTA: W9FIV — W9DGS — W9KXW/HJC — W9BN — W3CXL (Ar. 7.55 p.m. 3/3)

OHIO: W8ZG — W3CXL (Ar. 7.05 p.m. 3/3)

OREGON: (1) W7ZZL — W9ACL — W3LA (Ar. 6.28 a.m. 3/4) (2) ??? — W9AFT — W4NC — W3BWT (Ar. 8.11 a.m. 3/4)

PENNSYLVANIA: W3ADE — W3BWT (Ar. 5.15 p.m. 3/3)

SOUTH CAROLINA: W4GB — W4MN — W4NC — W3ASO (Ar. 7.05 p.m. 3/3)

SOUTH DAKOTA: W9IQZ — W9DKL — W9COS — W7ASQ — W9ESA — W9DGS — W9KG — W9FUT — W3OK — E3CXM (Ar. 1.15 a.m. 3/4)

TENNESSEE (SCM msg. behalf amateurs of Tenn.): W4AFM — W3CXM — W3CXL (Ar. 8.35 p.m. 3/3)

UTAH: W6EXL — W3LA (Ar. 10.08 p.m. 3/3)

VERMONT: W1BD — W3CXM (Ar. 6.25 p.m. 3/3)

VIRGINIA: (1) W3AAJ — W3LA (Ar. 5.35 p.m. 3/3) (2) W3FJ — W3BWT (Ar. 5.45 p.m. 3/3)

WASHINGTON: (1) W7AIT — W7AHQ (intercepted by W3ZD while being sent to W9DGD 7.07 a.m. 3/4) — W3BVG (Ar. 5.50 a.m. 3/4) (2) W7AIT — W9DMA — W3LA (Ar. 3.55 p.m. 3/4)

WEST VIRGINIA: (Gov.) W8CZ — W8EIK — W3ASO (Ar. 6.12 p.m. 3/3) (Gov.-elect) W8CZ — W8EIK — W3ASO (Ar. 5.53 p.m. 3/3)

WISCONSIN: W9IQQ — W3CXM (Ar. 12.15 a.m. 3/4)

WYOMING: W6DPJ — W1CJD — W3ASO (Ar. 9.40 p.m. 3/3)

ALASKA: (1) K7VH — K7PQ — W7UU — VE4DQ — W9IFE — W3BVG (Ar. 5.15 a.m. 3/4) (2) K7VH — K7PQ — W7UU — W7RT/ZZH — W4AFE (dld. W.U. 5.20 p.m. 3/4) (3) K7VH — K7PQ — W7UU — W7QI — W7AAT/COX — ???

HAWAII: K6COP — K6EWQ — W6PQ (WLVB) — W5OW — W3CXL (Ar. 11.14 p.m. 3/3)

P.I. (From all hams of P.I.): KA1XA or KA1LG — W6HM (mailed)

SPECIAL MESSAGES

VIRGIN IDS: (1) K4AAN — W5AHA — W9CKG — W8PP — W3NC (dld. W.U.) (2) K4AAN (fone) — K5AA — W2ADQ (3/5 Airmail Spel Dely) (3) K4AAN (14 mc. fone) — W8WA — W8FJL (7 mc.) — W3LA

(Ar. 12.18 a.m. 3/5) (4) K4AAN — W9DZS — ???

Several other messages were sent which were not officially connected with the relay, including one from the presidential elector of Nevada via W6UO, W9FUT, W2DQK; one from the Democratic committee Portland, Maine, via W1CRP and W1AFB; one from Uruguay via CX10A, W6JN, W2UK and W3CMA, and felicitations via the Minister of Panama via NY1AA, W1MK and W3BWT.

OA4U—On the Roof of the World

(Continued from page 9)

and cold-water supply; it is in the same building with the radio equipment so that work at night and in the early morning may be done with the least amount of discomfort to the operator.

The antennas consist of a current-fed Hertz 325 feet long and 75 feet high for transmitting, and a similar type antenna 40 feet high and 200

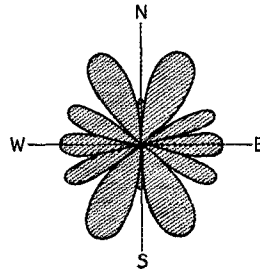

FIG. 1 — DIRECTIONAL CHARACTERISTICS OF THE 325-FOOT ANTENNA OPERATED AT 14,012 KC.

feet long for receiving. They are supported upon poles depending on guy-wires for rigidity. An underground antenna is used for receiving when the static gets too bad on the large antenna.

Schedules are kept with K5AA, NY1AB in Panama, KA1HR in the Philippines and with LU3DE in La Plata (Argentina) for traffic. The traffic through the Canal Zone goes to W2ADQ for distribution in the United States, and the bulk of this traffic is related to measurements made at Huancayo and in Washington, and also at the institution's Watheroo Observatory in Western Australia.

There is at the Observatory a well-equipped machine-shop for doing machine-work when needed in connection with radio problems.

The country near the Observatory is very beautiful and many interesting and profitable days may be spent riding about among the native villages.

At present the operator at OA4U is Harry Wells, ex W3ZD, and later, PMZ.



W4BHK is an operator — Linotype in daytime, talking picture projector at night and a ham in his spare time!

# A Flea-Powered Portable 'Phone With Crystal Control

By G. W. Fox, R. J. Pieracci, and W. L. Huebner\*

**A** PORTABLE 'phone always arouses interest among amateurs. There is a fascination in stopping outside a strange town, plugging in the mike, throwing a switch or two and calling

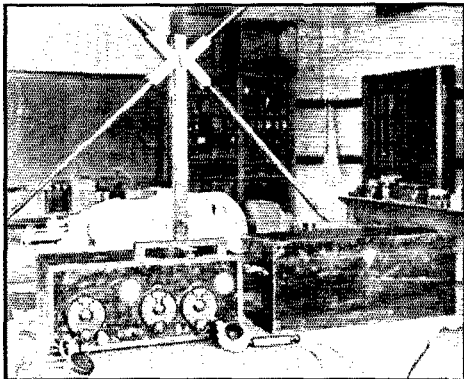

THE COMPLETE OUTFIT, WITH POWER SUPPLY BOX AT THE RIGHT

a CQ — especially if you are out of your own district. If you have never toured with a portable, you have missed a lot of the fun connected with the amateur game.

The portable set here described has several novel features by means of which it attains the

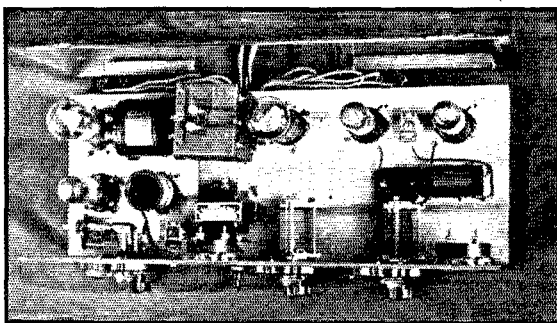

THE PARTS ARE ASSEMBLED "BASEBOARD" STYLE WITHOUT CROWDING

simplicity and reliability necessary in such a communication unit. First, it has a small collapsible loop which acts simultaneously as the radiator and the tank coil of the modulated stage.

\* Physics Laboratory, Iowa State College, Ames, Ia.

Second, the same batteries are used for transmitting and receiving — a single toggle switch making and breaking six circuits at once. Third, the crystal holder is of the evacuated type and can be used in any position. Fourth, the outfit may be put in operation in less than one minute.

The transmitter is entitled to its name. It has an input of about one watt to a Type '30 tube in the final stage, operating on 3935 kc. After the various losses have been subtracted, the output power approaches the magnitude of flea power. Operating with the call W9JOV and with this low power radiated from the loop, consistent 'phone communication has been maintained with W9JI at a distance of seven miles in the daytime. The modulation was excellent. Later tests have extended the range at night to ten miles, although

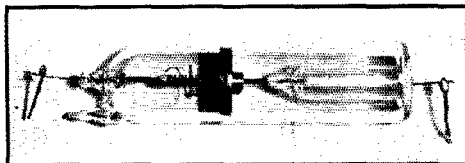

THE HOME-MADE VACUUM TYPE CRYSTAL MOUNTING

the QRM problem then becomes troublesome. By substituting a small plate coil for the loop and coupling to the regular transmitting aerial at W9JI, several conversations have been held with stations more than fifty miles distant. Such transmissions are not regular affairs, however. The QRM in the 75-meter 'phone band is so severe that it is difficult to make real DX tests.

The first photograph shows the complete layout. The power is contained in the box at the right, which is large enough to hold the 'phones and the microphone when these are not in use. A much smaller power box could have been built. The one in the figure houses the largest size of 45-volt "B" batteries. The cabinet on the left contains the "works," with the receiver at the left side. Above is the collapsible loop. The second photo shows the arrangement of parts inside the case.

The diagram of the transmitter (Fig. 1) is self-explanatory and shows the circuit constants. The oscillator is a Type 30 tube in the conventional crystal circuit. Ninety volts are supplied to its

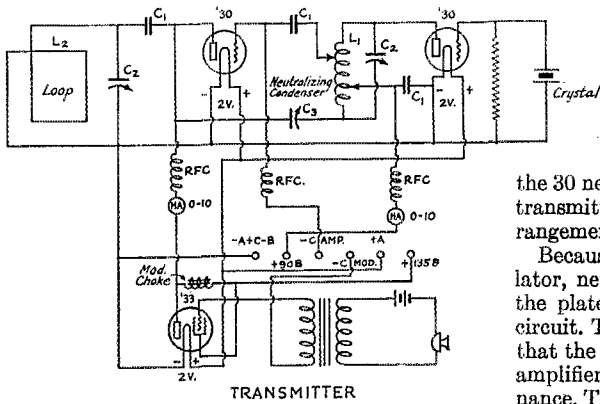

FIG. 1 — THE SCHEMATIC CIRCUIT IS ACCORDING TO STANDARD

In the transmitter, condensers  $C_1$  are .001  $\mu$ fd.,  $C_2$  are 13-plate midgets and  $C_3$  is a 2-plate midget. Oscillator coil  $L_1$  has 25 turns of No. 28 enameled on a  $1\frac{1}{2}$ -inch form.  $L_2$  is the loop described in the text.

plate. The two electrodes of the crystal holder are of the same size as the quartz plate and are slightly pressed together by the light spring. The assemblage is sealed into a closely fitting glass tube which prevents any sidewise motion. The holder has been baked out during exhaustion and sealed off. This type of holder has proved very satisfactory in several installations. It provides a unit completely free from trouble and so small that it requires a minimum sized cabinet where temperature control is desired. Evacuating the holder allows the use of higher plate voltages because there is no danger of arcing between the electrodes.

The amplifier, operated Class C, is also a Type 30 with 135 volts on the plate. The neutralization scheme shown leaves the loop untapped, which is more convenient.

The modulator is a Type 33 pentode in the usual Heising arrangement. With a grid bias of 14

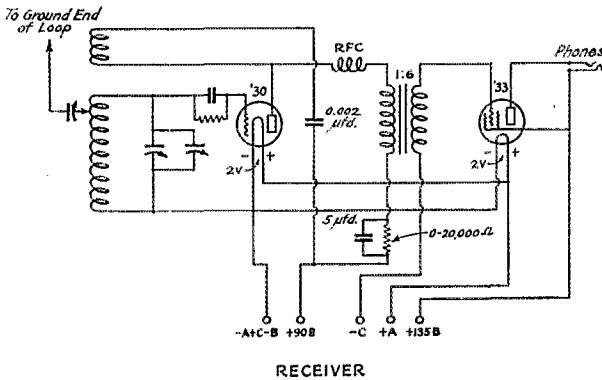

FIG. 2 — THE RECEIVER CONSISTS OF REGENERATIVE DETECTOR AND PENTODE AUDIO

The specifications are usual, as for receivers in The Radio Amateur's Handbook.

volts and plate voltage of 135, it operates Class A. The speech input is fed directly into the tube through a modulation transformer, a  $4\frac{1}{2}$ -volt C battery providing microphone current. Operating under these conditions, the 33 is capable of modulating

the 30 nearly 100 percent. The adjustment of the transmitter is the same as for any m.o.p.a. arrangement.

Because of the low power of the crystal oscillator, neutralization is determined by observing the plate milliammeter in the crystal oscillator circuit. The neutralizing condenser is adjusted so that the milliammeter does not "kick" when the amplifier tank condenser passes through resonance. To operate the Type 30 as a Class C amplifier, a grid bias of about double the cut off value is required. This can be found experimentally or by doubling the quotient of the rated plate voltage and the amplifying factor of the tube.

The circuit of the receiver with the constants is shown in Fig. 2. The detector is a Type 30 and the amplifier a Type 33 coupled through a high ratio transformer. The antenna connection is to the ground end of the loop.

The metal parts of the 40-inch square loop are brass. Phosphor bronze braided fish line, two turns an inch apart, rests on bakelite supports at the ends of the wood spreaders. In folding, the loop breaks at the center hinge thereby allowing the arms to fold into a position parallel to the center shift. The loop stand also folds and the whole fits into a canvas carrying case.

## Strays

If your town has police radio it might pay to curb that impulse to make changes in the antenna system in the wee small hours. W2BYE went out on his roof about one a.m. to check upon the feeders and in less than a minute the cops were on the job — with shootin' irons and all! It seems some neighbor had spotted BYE prowling around on the roof and thought it was a burglar.

When testing to see if a transformer winding is continuous, many hams are accustomed to using a small electric-light bulb connected in series with the 110-volt line. If the winding delivers high voltage the resistance may be too great to permit enough current to flow to light the lamp. In cases like this one of the small neon bulbs, substituted for the lamp, will make a good indicator, since the current taken by the neon bulb is minute.

— W2BYE

# Match Your Impedances

## Figuring Audio Transformer Ratios to Do the Job

By Daniel E. Noble\*

IN THE operation of radiotelephone transmitters and receivers the amateur is confronted with a number of problems quite different from those encountered in c.w. telegraphy. One of the most important of the problems is concerned with the determination of proper impedance relations in the audio frequency circuits. If one is to judge by the quality of transmission from some of the 'phones on the air, it seems evident that the effect of improper impedance matching on distortion is not clearly understood by many.

The elementary treatment offered below is intended to assist the beginner, and in order that the points to be made may not be obscured, the number of qualifications for the statements made will be limited.

The following questions will be considered:

1. What is the impedance ratio of an audio transformer and how does it relate to the turns ratio?

2. How may the turns and impedance ratios of a transformer be determined for a particular vacuum tube circuit?

3. What happens to the output of an amplifier when we upset the proper impedance relations?

Assuming a perfect transformer (one with no losses) the power output must equal the power input. In other words, the transformer simply acts as a transfer device; it changes the voltage without changing the power. Look at Fig. 1. Amplifier A will deliver its rated output of 10 watts to resistance  $R_1$ , which is 10,000 ohms. The power will be expressed by the simple relation  $W_1 = E_1^2/R_1$ , where  $E_1$  is the effective audio voltage across the resistance and  $W_1 =$  watts. Suppose, now, you wish to dissipate the energy output of the amplifier at the rate of ten watts supplied to a 500-ohm resistance instead of a 10,000-ohm resistance. If you simply replaced the 10,000-ohm unit with the 500-ohm unit and other factors at the amplifier, including the voltage, remained the same (they wouldn't), then the 500-ohm unit would dissipate energy at the rate of  $E_1^2/500$  as compared to  $E_1^2/10,000$ , or a total of 20 times 10 watts or 200 watts. It is clear from this that the voltage must be reduced so that  $E_1^2/500 = 10$  watts if we are to satisfy the required conditions. Now is the time to put in the perfect transformer and place the 500-ohm resistance, which we shall designate as  $R_2$ , across the secondary.  $E_2$  will then be the voltage across  $R_2$  and  $E_2^2/R_2$  must

equal 10 watts. The primary of the transformer replaces  $R_1$  and, since we assume that the transformer is perfect, the rate of energy dissipation must be the same in  $R_2$  with the transformer as with  $R_1$  without the transformer. That is:

$$\frac{E_1^2}{R_1} = \frac{E_2^2}{R_2} \text{ or } \frac{R_1}{R_2} = \frac{E_1^2}{E_2^2}$$

Since the voltage ratio of a transformer is the same as the turns ratio we may write:

$$\frac{R_1}{R_2} = \frac{T_1^2}{T_2^2}$$

where  $T_1 =$  primary turns and  $T_2 =$  secondary turns.  $R_1/R_2$  is, then, the ratio (called the impedance ratio) between a primary load resistance



FIG. 1

and a secondary load resistance for a constant power output. The expression  $R_1/R_2 = T_1^2/T_2^2$  shows that the impedance ratio is equal to the square of the turns ratio in a perfect transformer. In practice the transformer efficiency is high enough so that the equation may be used without introducing serious errors.

Refer to Amplifier B: If we look from the amplifier through the transformer to  $R_2$  it is clear that  $R_2$  must appear as  $R_1$  in order that the amplifier may be properly loaded. By selecting the proper turns ratio as indicated in the equation above, the transformer can be made to satisfy such a condition. Example:

$$\frac{R_1}{R_2} = \frac{10,000}{500} = \frac{T_1^2}{T_2^2}. \text{ Therefore } \frac{T_1}{T_2} = \sqrt{\frac{10,000}{500}} = \frac{4.47}{1}$$

This means that 500 ohms across the secondary of a properly constructed transformer will look like 10,000 ohms from the primary if there are 4.47 times as many turns on the primary as there are on the secondary.

Could we put 4.47 turns on the primary, one turn on the secondary and let it go at that? Not at all. That is the reason for the phrase "properly constructed" in the sentence above. It is a long story, but we shall take time to state it this way: With the secondary open, the primary impedance should be very large, compared to the source impedance, at the lowest frequency to be transferred. That explains the large size of the quality audio transformers made for a low frequency

\* WCAC, Conn. State College, Storrs, Conn.

limit of 30 cycles. If the primary winding is too small it will act simply as a load on the tube at low frequencies. With the idea of impedance ratio clearly in mind, the theory of impedance matching becomes quite simple. Consider a few examples.

1. Your microphone has an impedance of 200 ohms and you wish to couple it to the grid of a Type 56 tube with a 500,000-ohm leak across the grid circuit.

$$\text{Impedance ratio} = \frac{200}{500,000} = \frac{T_1^2}{T_2^2}$$

$$\text{Turns ratio} = \sqrt{\frac{200}{500,000}} = \sqrt{\frac{1}{2500}} = \frac{1}{50}$$

Therefore, the secondary must have 50 times as many turns as the primary. The use of the leak

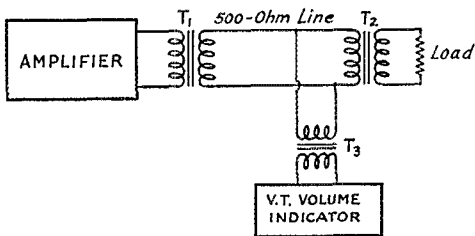

FIG. 2

to set the secondary impedance will reduce frequency distortion.

2. You wish to couple the output of a Type 12-A tube to a 500-ohm line. If the tube has a dynamic plate impedance of 4000 ohms we can load it with 8000 ohms to obtain maximum output with a minimum of distortion. (If you must load a pentode obtain a data sheet and find the load recommended; but all three-element tubes may be loaded with approximately twice the dynamic plate impedance for best results.)

$$\text{Impedance ratio} = \frac{8000}{500} = \frac{T_1^2}{T_2^2}$$

$$\text{Turns ratio} = \sqrt{\frac{8000}{500}} = \sqrt{\frac{16}{1}} = \frac{4}{1}$$

That is, the primary must have 4 times as many turns as the secondary.

3. What would happen to Case 2 (tube and transformer operation) if the secondary of the transformer were loaded with 100 ohms instead of the proper value, 500 ohms?

Since the impedance ratio is 16 to 1, the 100 ohms would appear at the primary as 1600 ohms. Loading the tube with such an impedance so far below the dynamic impedance of the tube would greatly increase the harmonic distortion. (An effect associated with the departure from linearity of the tube characteristic.)

4. Look at Fig. 2. The problem is to couple the

volume indicator to the line. The correct arrangement for coupling the line to the volume indicator (the power transfer is negligible) would be to use a transformer in such a way that the reflected impedance at the transformer primary would be as large as possible compared to the line impedance in order that the effect of adding the transformer to the line might be very slight. An ordinary audio interstage step-up transformer could be used with the primary connected to the grid circuit of the vacuum-tube-voltmeter volume indicator and the secondary across the line. Care should be taken to make sure that the indicator operates without drawing appreciable grid current, or the reflected impedance of the grid with a positive bias might load the line. (Particularly important if the transformer is used step-up.)

5. A variable resistance is placed across the secondary of an interstage transformer to act as a volume control. What effect will it have? If the transformer is designed to function in relation to the tube with a minimum of distortion when the transformer secondary is shunted with  $\frac{1}{2}$  megohms, any reduction in the secondary load resistance will decrease the load resistance on the tube in the primary circuit. The result will be increased harmonic distortion as the shunting variable resistance is decreased. This same type of distortion is produced automatically every time the grid of a tube goes positive. The distortion occurs, not necessarily in the tube with the positive swinging grid, but rather it occurs in the preceding tube. The positive grid presents a lowered

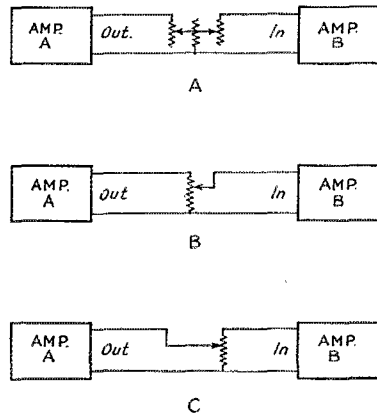

FIG. 3

impedance to the secondary of the coupling transformer. This reduced impedance reflected through the coupling transformer loads the tube connected with an impedance below the optimum value and there is an increase in harmonic distortion. Since Class-B audio amplifiers normally operate with positive grids, the transformer coupling from the preceding stage to the Class-B

grid is a step-down transformer. This arrangement permits the low grid impedance to be reflected through the transformer to the preceding tube as an impedance large enough for proper loading. In this way distortion is avoided.

6. An audio amplifier designed to feed a normal load of 500 ohms is connected to a 5000-ohm load. How will the output and quality be affected? If we assume that the impedance ratio of the output transformer is 10-to-1, the 500-ohm load would "look" like 5000 ohms to the tube plate and the 5000-ohm load would "look" like 50,000 ohms. Assuming perfect regulation, the voltage across the 5000-ohm load and that across the 500-ohm load will be equal. The power in each case will be  $E^2/5000$  and  $E^2/500$ . This shows that the rate at which energy is dissipated in the 5000-ohm load is one-tenth as great as the rate in the 500-ohm load. In general, it may be said that increasing the effective load resistance in the plate circuit decreases the harmonic distortion and decreases the power output.

7. Two amplifiers are to be connected together with a volume control between. (See Fig. 3.) In an ideal case, where the output impedance and the input impedance are both 500 ohms, a volume control designed so that it will always present an impedance of 500 ohms, regardless of its setting, is used. (Fig. 3A) But the amateur is not likely to have the necessary constant impedance volume control, and in that case he may wish to use an ordinary potentiometer, or more properly a voltage divider, to control the volume. In Fig. 3, B and C show two circuits using potentiometers as volume controls. One of the circuits, B, will work quite well and the other, C, will work with greatly increased distortion at low volume levels. For our explanation we shall assume that amplifier A has an output impedance of 2000 ohms and that amplifier B has an input impedance of 5000 ohms. If we connect a 5000-ohm potentiometer as shown in B the smallest load resistance (2,500) will be offered to amplifier A when the control is set for maximum volume. Turning the control to decrease volume will lower the resistance in the input circuit of amplifier B and, at the same time, increase the load resistance on the output of amplifier A. Lowering the reflected impedance at the grid circuit of amplifier B will not cause any serious difficulty, since loading up the grid of a tube does not result in distortion (qualifications omitted). Increasing the load resistance on amplifier A output will decrease output and decrease distortion.

In circuit C, however, the load resistance on the output of amplifier A will be decreased as the control is turned to reduce volume. The resulting decrease in the reflected load resistance on the output of amplifier A will increase distortion. Clearly, the distortion produced at low volume adjustments must be very great.

Observance of these simple rules of impedance

matching will eliminate serious distortion in the coupling of audio circuits.

## Economical Use of a Milliammeter

(Continued from page 29)

if calibrated is quite as good as those sold for the purpose.

Now that we have the milliammeter arranged so that it will do all the measurements, we may fix up one meter for each purpose, or we may use one meter for everything by suitable arrangements of jacks and plugs. Many other uses for the meter with its attachments may be devised, and also many other ways of connecting it to the apparatus to be measured. A pencil and paper will aid you to get the arrangement you want, for anyone can do it.

## Announcing the A-1 Operator Club

TO BECOME a member of the "A-1 Operator Club" you must be nominated by an operator who already "belongs." The list of "charter members" appears herewith. Each operator listed is being requested to submit his nominations of "A-1 Operators." When the club gets under way it is hoped that enough nominations will be received so that it will be possible to require more than one nomination for each operator before he is admitted. Lists of new members will appear in *QST*.

In choosing operators for the "A-1 Operator Club" the following points will be used: (1) General keying. Well formed characters and good spacing will be considered before "speed." Similarly, good voice operating technique, clearness, brevity, coöperation with other operators, careful choice of words, etc., may be used as criteria in nominating 'phone operators. (Special extra credit may be given for use of standard word-lists in identifying calls and unusual expressions.) (2) Procedure. Use of correct procedure is a natural qualification. This applies to both general operating and message handling. (Procedure as recommended by A.R.R.L. in the R. & R. and the *Handbook* is a good standard.) Long CQs, unnecessary testing, long calls without signing, too much repetition when not requested, and all other such poor practice, are grounds for disqualification. (3) Copying ability. This to be judged by proficiency in copying through QRM, QRN and other difficulties, and accuracy of copy, as well as by ability to copy at fast speeds. (4) Judgment and courtesy. The "CUL 73" type operator can never make the grade. An operator should be courteous and willing to consider the

(Continued on page 48)



# STRAYS



Built in 1922 the William H. Maybury Sanitarium, Northville, Michigan, home of 500 tubercular patients, is not wired for radio. The Goodfellows' Club, an organization of patients doing good deeds for other patients, proposes to do the job for the benefit of all. Already necessary wire and all-wave receivers, and needed parts have been donated. The remaining equipment necessary are plugs and jacks to provide headphone connections for all patients. The Club appeals to all hams, through A. O. Medice, W8LQ-ex-6DQW, to dig down into the old junk pile for spare plugs and/or jacks, and send them along to the Maybury Sanitarium.

While thinking of ways and means to dispose of a batch of 01-A's that were beginning to get underfoot we evolved this "super-reflex transmitter." The diagram is almost self-explanatory.

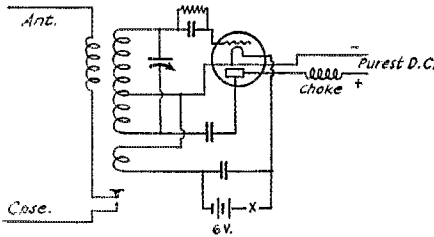

After the battery starts the tube oscillating the circuit supplies its own filament voltage.

The surprising thing is that we have worked a number of stations using no filament voltage and received very nice reports. However, we do not think that it will revolutionize transmitter construction.

— W9DBB-W9AYM

A ham from Cleveland, Ohio, writes in to say that it pays to attend hamfests. Six hams in his town journeyed to a near-by town for a hamfest and in the prize-drawing all six received prizes, ranging from a condenser mike to a 40-meter crystal.

When the rubber feet on the bug become glazed so the bug will no longer sit still while in use, just tack down a piece of sandpaper, and place it on this. It will stay put then under the hardest of use.

— W7BYG

With the announcement of two new League publications, *The Radio Amateur's License Manual* and *Hints & Kinks*, in the June, 1933, issue of *QST*, it has been noted that all League publications are now numbered as part of the Radio Amateur's Library. Many requests have been received for the complete list. It is given below.

Publication No.	Title	Price
1	<i>QST</i>	\$2.50 per year
2	<i>List of Stations</i>	(out of print)
3	<i>Map of Member Stations</i>	(out of print)
4	<i>Rules &amp; Regulations of Communications Dept.</i>	Free to members; to others 10¢
5	<i>The Story of The A.R.R.L.</i>	Free to members; to others 10¢
6	<i>The Radio Amateur's Handbook</i>	\$1.00
7	<i>The Log</i>	40¢ each; 3 for \$1.00
8	<i>How to Become a Radio Amateur</i>	25¢
9	<i>The Radio Amateur's License Manual</i>	25¢
10	<i>Hints &amp; Kinks for the Radio Amateur</i>	50¢

## Club Directory Available

A directory of the local amateur radio societies affiliated with the League, showing their times and places of meetings, is available to members upon request, enclosing three-cent stamp, please. Address the Communications Manager. Traveling amateurs will find this list helpful in visiting other clubs.

## Tube Checker Correction

TWO errors were made in drafting the circuit diagram of the universal tube checker and circuit analyzer on page 23 of the June issue. The center binding post of the d.c.-a.c. voltmeter connections is shown connected to the grid return circuit, or third switch position. Actually, it should be connected to the cathode circuit, or fourth switch position. The second error was in not showing the filament connection to the cathode circuit, necessary when filament-type tubes are being checked. This is done by simply connecting one side of the filament to the 0 voltage terminal on the transformer.

We want to emphasize again that all rotary switches must be set at the "off" position when the device is to be used as an analyzer. Otherwise both tubes and apparatus may be ruined.

for the

# EXPERIMENTER



## 83's in High-Voltage Rectifiers

**I**N THE letter quoted below, Messrs. C. J. Pearce and L. C. Waller, of RCA-Radiotron, emphasize some precautions which should be taken in using Type 83 mercury-vapor rectifiers in bridge circuits for high voltage, and supply some additional information on operating the tubes in this type of circuit:

"We would call your attention to a statement in the article 'A Duplex Plate Supply Using Type 83 Tubes' in March QST. On page 31 the statement is made that 'The inverse peak voltage just meets the tube manufacturers' recommendations.'

"To our knowledge, Type 83 tubes made by all manufacturers are rated at 1400 volts maximum inverse peak. An inspection of the circuit shown on page 31 (reproduced here in essentials in Fig. 1) shows that at the instant when the upper end of the high-voltage secondary is a positive maximum ( $1.4 \times 1200 = 1680$  volts) there is an instantaneous potential difference between plate 2 and the filament of VT-3 of 1680-15 or 1665 volts, approximately. Also, the four plates of VT-1 and VT-2 are at the same instant only 15 volts positive with respect to the lower end of the secondary; this means that both plates of VT-1 are negative by 1665 volts with respect to the

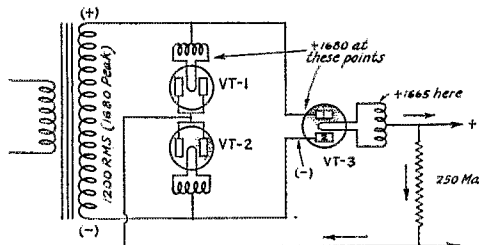

FIG. 1

filaments of VT-1, which are still at the positive peak at the instant under consideration. On the next half cycle the conditions of course are reversed, the voltage strain coming between plate 1 and the filament of VT-3 and between both plates and filaments of VT-2.

"The actual amount of the voltage overload is not very large, but many amateurs, assured that the tubes are working *within their rating* at 1200 volts r.m.s., will unhesitatingly use 1500 or more, on the basis that tubes are usually good for some overloading. This practice should not be recom-

mended. A fact not generally appreciated by amateurs is that conservative operation of their tubes is usually more economical as well as giving more reliable and satisfactory performance.

"The system as shown has considerable merit, if the maximum r.m.s. transformer voltage is

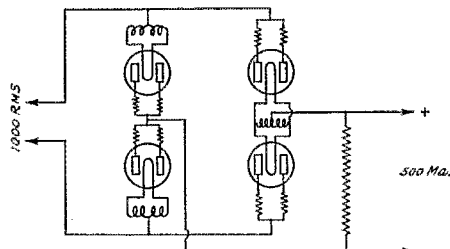

FIG. 2 — WITH FOUR 83'S INSTEAD OF THREE THE OUTPUT CURRENT MAY BE INCREASED TO 500 MILLIAMPERES

The equalizing resistors in each plate lead are essential to cause the load to divide between the plates of individual tubes. The resistors should be 100 ohms each; 50 ohms may be sufficient if the full 500 ma. is drawn.

reduced to 1000 volts (1400 peak). However, if a fourth 83 is placed in parallel with VT-3 (see Fig. 2), the system will deliver 500 ma. instead of 250, provided that plate load-equalizing resistors are used. Doubling the current output with the addition of only one more tube is an obvious advantage.

"Some very useful combinations can also be obtained by adding the fourth tube in the two-voltage system shown on page 32 (March QST). As before, the total transformer voltage should not exceed 1000 r.m.s. volts, and plate resistors should be used. The following current combinations are then possible:

From H. V. Source, ma.	From L. V. Source, ma.
450	50
350	150
250	250
150	350
100	400

"Any current may be drawn from the two voltage supplies as long as the total does not exceed 500 milliamperes.

"The disadvantage of reducing the transformer voltage, and hence the output voltage, can be overcome by using a condenser-input filter of ap-



proximately two microfarads, instead of choke input. With this change, d.c. voltages of 1000 or more can be obtained from a transformer delivering 1000 volts r.m.s. The high current peaks with condenser input are within the peak current rating of the 83. The regulation will not, of course, be as good with the condenser input filter, but it should be adequate for any keyed Class "C" amplifier stage.

"The use of the resistors in each 83 plate lead is essential if the rectifier is to be used at the 500 milliamper rating. Otherwise, as is well known, the plates will not divide the load equally and the tubes will be damaged."

### A Different Keying Tube Circuit

The circuit shown in Fig. 3 was devised by the writer for W4BAT, who uses a single 10 Hartley drawing 60 mils at 550 volts. I believe it is about

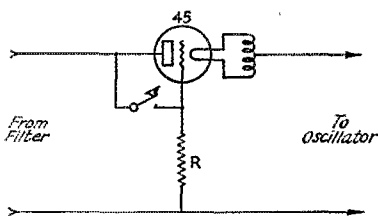

FIG. 3 — A VACUUM-TUBE KEYING CIRCUIT FOR ELIMINATING CLICKS

The resistor  $R$  may have any value which makes the current drain through it small when the key is closed. For a 500-volt plate supply W4IS used 225,000 ohms with success.

the ultimate in simplicity and effectiveness. The tube drop is nearly negligible when a single 45 of normal characteristics is used to key the load mentioned. The cut-off is complete even though it would not appear so at first glance at the circuit. Actually the current is so low as to be scarcely perceptible on the milliammeter. The tube drop is very low because the grid is tied to the plate when the key is down, and there is no interfering (bias producing) resistor in the grid circuit when the key is pressed. The resistor  $R$  is nothing more than three solid carbon 75,000-ohm resistors in series which gives more than the necessary dissipation. There is no objection to tying the grid and plate together as under the conditions which exist the grid current is not dangerous to the grid structure. It is only when the grid is more positive than the plate that a damaging grid current would flow and this is not the condition in the circuit shown. Since W4BAT already had an extra  $2\frac{1}{2}$ -volt winding on the power transformer, the cost at net prices was less than \$1.00.

The key breaks the current which flows through the resistor, and since this current is of the order of a mil or so and is in shunt with the power supply, not in series with the load, any spark has negligible effect on the output of the oscillator. As

a matter of fact the spark produced was not perceptible in daylight and was of no noticeable effect. A single 45 will suffice to key a load of 60 mils or more with small voltage loss. Without changing any constants two or more 45's or other types could be paralleled to key heavier loads. The keyer tube obviously will run cool as its internal resistance is made very low when the grid and plate are tied together. It is obvious also that the tube has less internal resistance than a rectifier or two-element tube of similar construction, as a result of the fact that the grid neutralizes the space charge with some degree of completeness when it is tied to the plate.

Of course the simple circuit shown can be applied to loads of greater current and voltage by using different constants. In any case the resistor  $R$  should be high and of sufficient size to dissipate the necessary heat. The formula  $W = E^2/R$  will give the watts to be dissipated by the resistor when  $E$  is the voltage of the power pack and  $R$  is the resistance in ohms.

— J. D. Blüch, W4IS

### A Junk Box Voltage Regulator for the M.G.

Those who use a motor generator for plate supply and require close regulation will be interested in this voltage regulator, which cost 15 cents at the five-and-ten. The 15 cents was expended for two tungsten contact points (Ford) and a bird-cage spring. The rest of it comes from the junk pile. It is conventional in every way; see Signal Corps Pamphlet No. 40, 1921, page 190. The heart of it is an ancient audio transformer, a Thordarson 6-to-1 in this instance.

The diagram, Fig. 4, is slightly clarified from the Signal Corps description. In operation the field rheostat of the generator is short-circuited

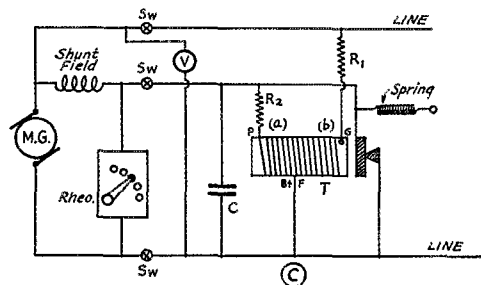

FIG. 4 — VOLTAGE REGULATOR FOR THE MOTOR-GENERATOR SET MADE FROM AN AUDIO TRANSFORMER AND FORD CONTACTS T — 6-1 audio transformer (Thordarson). Secondary winding at (b); primary winding at (a).

$R_1$  — 3000 ohms.  
 $R_2$  — 5000 ohms.  
C — 2  $\mu$ d., 400-volt rating.

by the contacts as the line voltage rises and falls about a given point, determined by the tension of the spring. The core of the transformer is re-

formed into a W-section across which the vibrating armature is hung by taking out one leg. The primary and secondary of the audio transformer provide the control and bucking coil of the instrument, with suitable resistances in series with each to hold the current to safe operating values.

In the instrument I describe, the secondary of the transformer is the control magnet (b). It is connected directly across the line, with 3000 ohms in series. As the voltage of the line rises, the control magnet opens the contacts, making the rheostat operative in the shunt field of the generator. This causes the voltage of the generator to fall, which weakens the control magnet and allows the spring to close the contacts again. The cycle repeats itself rapidly, causing the line voltage to float about a given point, at any point on the line to which the regulator is attached.

The bucking coil A (the primary of the transformer) refines and quickens the action. When the contacts are closed, both the field rheostat and the bucking coil (connected in reverse across the rheostat) are short-circuited and inoperative. When the contacts open, both become operative. The bucking coil demagnetizes the core, but its inductive lag delays this action long enough to permit the non-inductive resistance of the field rheostat to operate. Properly adjusted, this device will hold the voltage within a fraction of a volt about the desired point, within the capacity of the generator and prime mover. Each winding requires only a few milliamperes. The best operating density for the long arc between the contacts had to open more than an inch to make a complete break. Several systems of latches designed to hold the armature closed until an overload came on and to hold it open after the break proved unsuccessful.

The device described has been in 24-hours-a-day service for three months on a 3.5-kw. 125-volt water-wheel driven generator used for lights and small power; and its regulating properties are such that it controls the voltage perfectly from full load to runaway speed. The original contacts are still in use. They should be set very close — 0.02 inch or less — as the travel is very small.

In the audio-frequency transformer used here *G* is connected to the line and *P* to a point between the field rheostat and the shunt field. *B* and *F* are joined together by a jumper and connected to the other side of the line at point *C*. To determine the size of condenser across the contacts, operate the device near a b.c. receiver, add-

ing capacity until a quiet point is reached. I use a 2- $\mu$ fd. 400-volt condenser.

To put the regulator in operation, turn the field rheostat back until it gives desired voltage across the line at runaway speed. Then switch in the regulator, and adjust the spring until the voltmeter shows the desired voltage.

*P. I. Anderson, New Boston, Mass.*

### Homemade Overload Relay

Being of an experimental mind I am constantly making some change in my transmitter with the result that I am forever blowing fuses, so I decided to make an overload relay. Sounds simple but isn't I found that because of the varying load

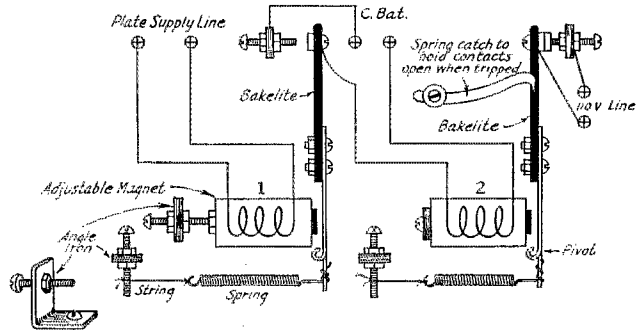

FIG. 5 — HOMEMADE OVERLOAD RELAY

Relay No. 1 in series with the d.c. plate supply line, closes when the plate current passes a predetermined value. This in turn closes the circuit of relay No. 2, which breaks the 110-volt supply to the power transformer. A spring catch prevents the armature of relay No. 2 from dropping back to its original position until released by hand.

caused by keying, the relay armature would not stay steady until the proper time to throw, and also that to break the high voltage was impracticable because of the long arc between the contacts. Using a 1500-volt plate supply, the contacts had to open more than an inch to make a complete break. Several systems of latches designed to hold the armature closed until an overload came on and to hold it open after the break proved unsuccessful.

The contacts were changed to make instead of break, and in making contact energize a second relay which in turn breaks the line supply. The transmitter "C" bias batteries are used to operate the second relay. The first relay, carrying the transmitter plate current, is wound with No. 25 d.c.c. wire; the second with No. 36 enameled wire. As shown in Fig. 6, the first relay is arranged to be adjustable, varying the space between the armature and pole, to take care of different load requirements.

On test this could be adjusted to trip at any load from 150 milliamperes up. Winding with smaller wire would permit it to trip on less load.

— *N. M. Patterson, W4EG*

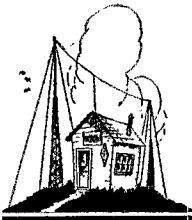

# Amateur Radio STATIONS

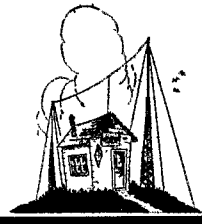

## NY1AA, Balboa, C. Z.

NY1AA's signal is well known to most amateurs operating in the 14-, 7- and 3.5-mc. bands. Also operating under the call NDG, the station is the Master Control of the Volunteer Communication Reserve, U. S. N. R., 15th Naval District.

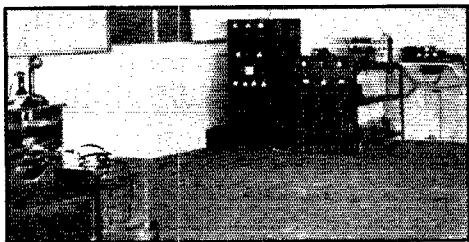

NY1AA, BALBOA, C. Z.

The three transmitters at NY1AA range in power from 15 to 500 watts. The 500-watt set is a push-pull t.g.t.p., using a pair of 204's, and is available for operation on any frequency in either of the three amateur bands. The next transmitter in power size is a 150-watt combination crystal and m.o.p.a. set operated on 3475 and 4045 kc. with the call letters NDG. The set uses a 10 oscillator, 865 first intermediate, 865 second intermediate and a pair of 852's in parallel as the final amplifier. It can be used on any frequency in the 3.5- and 7-mc. band when the oscillation is self-controlled. The low-power transmitter (15 watts) operates on any frequency in the 14,000-kc. band and is the same in circuit design as the 500-watt set except for smaller tubes.

Power for the 15-watt set is obtained from an Esco m.g. delivering 400 volts d.c. The 150-watt crystal set has a self-contained power supply. A 2000-volt 3.5-kw. m.g. set supplies the 500-watt transmitter. An emergency rectifier power supply is under construction.

Four receivers are in use: A National SW5 with band spread coils, as well as coils covering 550 to 30,000 kc., an experimental high-frequency receiver with a range of 3000 to 20,000 kc., a Navy Type RG-1 using peanut tubes and having a range of 1000 to 20,000 kc. and a model SE-1420 covering 300 to 7500 meters. The last is used for commercial work, SOS calls, press, etc.

The antenna at NY1AA is a single-wire-feed type cut for 3500 kc. Doublets are used for reception, one cut for each amateur band. The antennas are supported by 100-foot masts.

A modulator unit is under construction and should be completed this summer. Phone operation will be used in the 75- and 21-meter channels. NY1AA has recently conducted some 28-mc. tests and been heard in Canada and New Jersey, strength QSA3/5. Power used was approximately 300 watts input on the fundamental frequency of 14,200 kc.

The Commanding Officer of NDG-NY1AA is J. W. Young, Lieutenant DE-(G) USNR. E. W. Lockwood, Ensign C-V(S) USNR, is the executive officer. Communications and cards should be addressed to the Executive Officer, c/o Box 505, Balboa, Canal Zone.

## W8CPY, Ludington, Mich.

THE neat low-power station of Leo J. Vachow, 402 S. Washington Ave., Ludington, Mich., is shown in the accompanying photograph. A touch of the unusual in appearance is the uniform aluminum finish on each of the units in the station.

The receiver, at the left in the photograph, is a.c.-operated, with an untuned r.f. stage using a 24, Type 35 detector, 24 first audio and 210 output as second audio. It measures 6 by 9 by 6 inches. The speaker, a cone Farrand, is not shown but usually takes its place behind the receiver.

The speech amplifier and modulator, to the right of the receiver, uses a 27 first stage impedance-coupled to a second 27, impedance-coupled in turn to a pair of 50's in parallel. This unit measures  $5\frac{1}{2} \times 12 \times 1\frac{1}{2}$  inches over all.

The four-stage crystal-controlled transmitter, next in line beside the modulator, measures only  $9 \times 17 \times 1\frac{1}{2}$  inches. It consists of a 27 crystal oscillator, 24 buffer and doubler, 47 buffer and doubler and a pair of 210's in push-pull as the final amplifier.

All parts such as meter, key and cable power leads, crystal and tank coils are made plug in. A multi-connection cable is brought out through the back. The tap for modulation is brought out through the end nearest the speech amplifier.

Key and meter are plugged in the most handy place, the front. The tank coils for the first three stages are wound on the old standby — tube bases. These are tuned by 13-plate midget condensers. Series feed is used and the condensers are therefore all insulated from the metal sub-panel. The last stage coil is a self-supporting affair made of solid wire and plugs into jacks mounted on the transmitter chassis.

The key is inserted in the grid circuit of the final stage for blocked-grid keying. A single milliammeter serves to read plate currents for

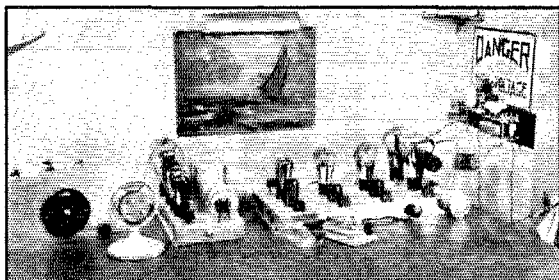

WSCPY

the various stages and also grid current on the last stage. This is a 0-5 voltmeter that previously was used in a Radiola Superhet, and was converted into a low range milliammeter by removing the series resistor inside the case and shunting it across the movable coil.

To use 'phone, the key plug is removed, putting the carrier on continuously, a cord with two plugs is inserted in jacks for the purpose on both transmitter and modulator, the latter is connected to its power supply and the set is ready to go.

The antenna is an 80-meter Zepp with either parallel or series tuning of the feeders. The antenna coils are also plug-in and made the same way as is the final tank coil, but are attached to the tuning panel on the wall. The coupling from final stage to antenna can be varied by moving the whole transmitter with respect to the antenna coil.

The power supplies are two metal panel affairs, one using an 83 rectifier for first three tubes and speech amplifier, while the second, with 866 rectifiers, furnishes 800 volts to the final stage and modulators.

With as low as 300 volts to last stage both coasts have been worked as late as 10:00 a.m. E.S.T. on 40 meters.

## Announcing the A-1 Operator Club

(Continued from page 36)

other fellow's viewpoint. He should QRS or QSZ, without "crabbing" when requested. He should embrace every opportunity to assist beginners, and to help them along through some

of the more trying experiences of operating. He should never knowingly QRM another station, but should cooperate as much as possible with stations working on his frequency. He should not decry "lid" operating but should assist the newer operators and offer friendly, courteous advice as to how they might improve their operation. The matter of "good notes," "sharp" signals, lack of frequency "wabbulation," good quality (phone), use of sound technical arrangement and proper adjustment, while not directly points of *operating* ability, are certainly concerned directly *with courtesy and judgment* and as such these things must be weighed under (4).

We suggest to A-1 operators, in considering candidates for nomination to the "club" that each of the four qualifications of paragraph two be carefully considered, each counting a possible 25 points (of 100 total). No operator nominated should have a rating of less than 15 on any qualification, and the total must be 80 or over to warrant a recommendation for a particular operator.

Regarding *disqualification*. After an operator has been nominated if exception shall be taken, or complaint made of faults in his operating work, copy of such complaint shall be sent to him in order that he may profit from constructive suggestions, or explain the circumstances. In the event of a sufficient number of objections to a nomination or lacking a satisfactory explanation, the call may be added to a "disqualified" list or record at Headquarters.

### A-1 OPERATORS

C.W.: **W1ATJ**, BD, BHM, BLI, CDX, CFG, CHF, CJD, CTI, DDK, "FS" and "Helen" at **W1II/ZS**, **W1IP**, **W1VS**, Bob Wilson at **W1YU**, **W2ACD**, **AIQ**, **BJA**, **BPY**, **BZZ**, **CO**, **LU**, **W3AAJ**, **AHD**, **ARV**, **BWT**, **CVU**, **CXM**, **FJ**, **GS**, **MC**, **OK**, **WO**, **ZI**, Ed Day at **W3SN**, **W4AJX**, **AVT**, **BOZ**, **DW**, **FTHA**, **JR**, **TO**, **W5AUL**, **BMI**, **EB**, **SL**, **VQ**, **ZC**, **W6AM**, **AKW**, **BJF**, **CUH**, **DPJ**, **HT**, **QA**, **W7AAT**, **ASQ**, **BB**, **W8AJE**, **APQ**, **BBH**, **BJO**, **BMK**, **BMG**, **CGS**, **CUG**, **DBX**, **DDS**, **DES**, **DLG**, **DSS**, **DYH**, **DZ**, **EIK**, **EVC**, **FGV**, **GB**, **GZ**, **PL**, **PP**, **W9AET**, **AZN**, **BAN**, **BKJ**, **BWJ**, **DDE**, **DGS**, **DZW/GP**, **ENH**, **EPJ**, **ERU**, **ESU**, **FA**, **FAM**, **FFD**, **FLG**, **FQ**, **FRA**, **KG**, **OX**, **UZ**, **VE3CP**, **GT**, **HA**, **VE4BB**.

PHONE: **W1AQM**, **AUJ**, **W2AWR**, **BYM**, **W8AJ**, **RD**, **W9DRD**.

## Strays

Here's proof that radio is advancing. A newspaper heading says, "New Blank Radio on Display; Has Tuning Control." And farther down we read that the new set has a full-version dial. Quite modern, that set!



# CALLS HEARD

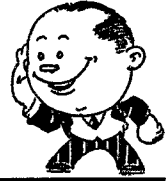

*W1FJE, "Bill" Hertz, 284 Third Ave., West Haven, Conn.*

(7000-ko. band)

*wuika j2ob kalhr ka1nf pk3gw xulf*

*G2HJ, K. E. Brian Jay, 19 Elm Close, Amersham, Bucks, England*

(14-mc. 'phone band)

*w1axa w2adi w2alk w2bey (?) w2op (?) w2gx ve3he sulec*

*W6CTM, B. D. Casentini, Box 53, Salinas, Calif.*

(14,000-ko. band)

*on4au ear185 zu5b*

*G6YL, Miss B. Dunn, Felton, Northumberland, England*

(3500-ko. band)

*w1ack w1amp w1ddy w1dtu w1lt w1ov w2bkp w2dvw w2dah w2ewu w2ze w3akn w4nc w5si w8bas w8ur w8uv un7kw w9bht (fone)*

(14,000-ko. band)

*w6ahw w6ahz w6bvx w6byb w6exq w6wb ce3ag om2an om2do om2jm om2wa om6dw cm8ok ox1aa holfg hc2ov hj1ab k4aan k4sa k5ab k5af k5aa lu1ca k4ru f3mta ny2ab py1dx py1lf py2bx py2qa py9am pk1ei pk4da rx1aa ti2wd ve5jn vk2ba vk2fq vk2fy vk2gw vk2hc vk2hw vk2lx vk2lz vk2oc vk2tx vk2xu vk2xy vk2zw vk3bj vk3bq vk3bv vk3bw vk3ow vk3dt vk3gq vk3jj vk3ml vk3mr vk3or vk3sk vk3wl vk4kg vk5gr vk5gt vk5hg vk5mf vk5my vk5wb vk5wp vp2mo vp2mr vp2yb vp4cf vp4tb vp5cc vp5gm vp5nh vq4rl vs6ae vs6ah vs7al vs7gj vs7gt vu2ah vu2it vu2lx vu2lz vu2ah vu2ow vu2pf zd2a zl2oi zl4ai zl3aq zslb zslh zsls zs2f zs2j zs4u zs4m st5v zuid Oxre x1aa xx2ae xzn2b xzn2c*

(7000-ko. band)

*w6am w6md kalhr kaljr kallg ka1xa pk1hg vk2pe vk2sg vk3bq vk3dt vk3lp vk3sq vk3wl vk6gf vs7gt zl2bt zslc zs2f zs4f zt2h zt2l zulp zu6a zu6w xx2ae xzn2b*

*Donald W. Morgan, 15 Grange Road, Kenton, Middlesex, England*

(14-mc. band, 'phones, Feb. 11th-April 30th)

*ve2ca ve2bg ve3he suleg su6hl w1caa w1xar w1axa w2gx w2adi w2aih w2aoe w2tt w2iam w2hn w2alk w3qv w4ql w5ceb w9bht w9drd w9kid w9ot*

*G2AAA, P. Powell, 3 Pepys Way, Girton Rd., Cambridge, England*

(3.5-mc. band)

*w1bb lbev lbbh lblj lbzq l1dd ldyw l1u zook 2div 2dqd 3cqs*

(14-mc. 'phone band)

*w2aog w8wa w9bht w9hrx w9bsz ve2bg ve3he*

*W7BB, E. R. Stevens, 915 13th No., Seattle, Wash.*

(March 16th to May 27th)

(7- and 14-mc. bands)

*ot1as ot1ws ct3ax ct3ox d4uan d4usb ei5f ei8b ear34 ear16 ear36 ear39 ear38 ear46 ear96 ear12 ear121 ear126 ear185 ear224 ear226 ear227 ear225 f8kj f8pz fm4bm g2bm g2io*

*g2nh g2di g5wp g5oj hb9af hb9j hb9u haf8b haf3zz la1g la2o l3bn oh3nf on4fe on4zo on4rtu ok2ak pa0go pa0qq pa0qf rmak rmau sulec uo3zf yi6er yi6bm sp3ar zilz zs4a Brad Burns, 114 Brigham St., New Bedford, Mass.*

(14,000-ko. 'phone band)

*g5nl ro8aw x1g yu2am*

*G6LK, E. Laker, 4 Alford Road, Cranleigh, Surrey*

(14-mc. band)

*w5ab 5ccb 5bnt 5mj 5czl 5uv 5cum w6byb w6ctv w6efr w6exq w6fko w6fz w6tj w7awq w7byf hc1fg hc2jm hi8x hj5abd hj1ab j1da j1ee j1eg j5cc k4aan k4sa k4aop k5aa k5ab k5af pk1ox pk4az ny2ab nylab rx1aa ti2rc ti2wd ve4ci ve4hm ve5fx vp2mo vp2mr vp2yb vp4aa vp4tb vp5gm vp5nh x9a x27b*

## The Iowa-Midwest Division Convention

WITH a total registration of 420 delegates this year's Iowa Convention held at Des Moines on April 28th-29th outshone all previous divisional affairs and credit goes to F. J. Sadilek and his committee. A program replete with interesting topics was carried out by such speakers as Prof. G. W. Fox and Mr. J. H. Deming of Iowa State College: Mr. Frazier of the Parrott Film Co. demonstrated the recording of sound on film. Mr. Detrick of McMurdo-Silver held the meeting with considerable interest in explaining their new receiver. Mr. Stedman talked on the "Application of National Electric Code to Amateur Transmitter Installations." Mr. Burden of the Lincoln T. & T. gave a talk and demonstration on "Spectrums, Audible Light, etc." Carl Menzer of the University of Iowa, Director Kerr and Ensign Morgan of the Navy all gave interesting talks.

Inspection of ham shacks, police broadcast and several other points were made and the committee saw to it that the delegates were kept interested. The convention coming to a close with a good banquet and speech by Mr. W. J. McDonald, Radio Inspector.

Well done, Des Moines!



W2DPH sends in the following formula to keep the drill lubricated in drilling holes through glass:

- Camphor, 1 oz.
- Spirits of turpentine, 1 1/2 oz.
- Ether, 3/8 oz.

# THE COMMUNICATIONS DEPARTMENT



F. E. Handy, Communications Manager  
E. L. Battey, Assistant Communications Manager



OUR section reports have required increased editing for the past three years to take care of the great growth in interest and activity in all branches of amateur work — experimenting, traffic, 'phone, etc. Only four years ago SCMs received an average of six or seven hundred reports (of all varieties of amateur communication) monthly, and felt that amateur work was flourishing. In the early months of this year our reporting section contained over 3000 independent reports on different amateur activities!

In spite of the steps taken to list reports more concisely the situation became acute early this year, and it was necessary to somewhat curtail the space devoted to sectional reports. Section Managers followed an editing plan that eliminated duplicate sentence-mention of part of the amateur stations already mentioned in the traffic summaries. This step was required not only to introduce a printing economy but to assist in maintaining the proper balance of technical articles and material on all phases of amateur communication, operating, and experimentation. Effective with April *QST*, new space limitations were adopted. At present we are following a sliding-scale of space determination for section reports which gives 8½ pages to 12 pages per month to activity reports from all amateurs, depending on seasonal considerations. We sincerely hope that every amateur appreciates the space problem and the necessity for S.C.M.s and Headquarters keeping these reports concise. Thru a complete monthly summary of reports it is possible to get a truly national picture of amateur activity. Your S.C.M. (see his address on page 5 of *QST*) invites and welcomes your postal-card report of what you have been doing in radio, on the 16th of each month. July 16 reports appear in September *QST*. This is one way to take part in your A.R.R.L. organization; we also suggest that you find out from your S.C.M. about the appointments as Official Relay Station, O.B.S., R.M., and O.O. and get your station lined up now for fall activities.

Are you an A-1 Operator? Excellence in stations has often been emphasized. Yet, station performance, equipment, adjustment, etc., are but part of the story. The operation of the equipment, knowledge of procedure, and general communications technique are of very great importance in determining the results of any station. To bring attention to good operating as a paramount issue, and give it something of the importance it deserves we are this month announcing in these columns the launching of a club for A-1 operators. From month to month we expect to mention the additions to the club membership which will be made only by election or on nomination of qualified members. A little study of operating pointers and the business of "operating a station" which is discussed in detail in the *Radio Amateur's Handbook*, coupled with regular use of the recommended procedure will improve results at many an amateur station. Look into it. All amateurs should strive to be first grade

operators. See the announcement of the new "club" and determine to be such a really-qualified operator.

— F. E. H.

## U. S. N. R. Active in Southern California Earthquake

SINCE publication of our story on the Southern California earthquake in May *QST*, the Navy Department has forwarded some pertinent information relative to the activities of members of the Naval Volunteer Communication Reserve during the period of that disaster. It is probably not generally appreciated that the Naval Communication Reserve is kept in constant training to meet just such emergencies. Again in this instance, as it had often done in the past, the Reserve functioned instantly and completely, due to its preparatory training and organization.

In the various reports received from U.S.N.R. officials in the quake area amateur operators of the following stations are mentioned as being of invaluable service during the period of the disaster. The majority of these amateurs, practically all of those in the sixth district, are also members of the Naval Communication Reserve, and conducted communication in line with Naval procedure: W6ABB, W6ADH, W6AIS, W6AOA, W6AWC, W6BAM, W6BCT, W6BEX, W6BOE, W6BPC, W6BSV, W6BVD, W6BYF, W6CAH, W6CQM, W6DBB, W6DEP, W6DER, W6DYL, W6EC, W6EDW, W6EFE, W6EGQ, W6EOP, W6EQW, W6ETJ, W6ETM, W6EZG, W6EZZ, W6EZX, W6FGT, W6FYF, W6GXM, W6HAQ, W6HEB, W6HEG, W6HT, W6MQ, W6NR, W6QA, W6RO, W2BGO, W5YH, W7BPO, W7CRH, W8IW, W9CSY, W9CVE, W9ERS, W9EYN, W9GBP, W9LFX, W9OIL.

Perhaps the greatest service rendered by the Volunteer Communication Reserve was during the week following the first shock. Numerous stations maintained practically continuous watch and handled many thousands of dispatches regarding relief activities for the Red Cross, National Guard, various city officials and personal messages regarding safety of residents of the stricken cities. At W6EC alone a total of 3683 messages were handled during a seven day period.

The big thing to remember about this U.S.N.R. emergency work is that it is "organized endeavor" and that it is carried out as nearly as possible in standard Naval style. The Naval Volunteer Communication Reserve stands ready at all times to repeat its excellent performance displayed during the California earthquake.

## Ohio Valley Flood

THE U. S. Naval Communication Reserve again stepped in to furnish emergency communication when, on March 18 and 19, a sudden flood emergency developed at Cincinnati and points above and below that point on the Ohio River and its tributaries. The Reserves were mobilized by radio and telephonic communication. Both

Fleet and Volunteer personnel reported to the Naval Reserve Army at Cincinnati for such duty as might be required. Communication aid facilities were immediately extended to Civil authorities, the telephone company, Western Union and Postal Telegraph, to be available in event such aid was required. All U.S.N.R. Unit Commanders along the Ohio River were advised to stand by for any assistance that might be required. The situation did not become so severe that radio communications were needed but the point of importance is that "a communications network was ready, had it been needed." Amateurs who do not happen to belong to the Naval Reserve would do well to pattern after the Navy's policy of "being prepared." Lt. H. F. Breckel (W8NC), Commander of the U.S.N.R. Section at Cincinnati, and an active amateur, has been highly commended for the able manner in which he has organized his Section for emergency work.

## 1.7 mc. 'Phone in California 'Quake

W6HMW-HMX sends some "hot" dope on activities of 1.7 mc. 'phones during the California earthquake. 1.7 mc. 'phone facilities were taken over by the California National Guard. A network was run smoothly with W6GOY at Artesia, as key station, and W6GSR at the Long Beach Armory as control station. The city of Compton, right in the center of the devastated area, was without any means of communication, so W6FXE and W6GXH traveled over there and set up their portable (FXE) in an Army tent in front of the city hall. W6HMW, who had been on the air 50 hours working W6GZQ, Huntington Park station, went to Compton to assist in the operation of W6FXE and stayed on the air another 48 hours as assistant operator. Numerous other amateurs rendered valuable assistance at the stations mentioned and they must not go without commendation: W6FHN, W6DNR, W6GWX, W6HCH, W6HHU, W6EEA, W6HBN, W6DIC, W6AAA, W6CBF, W6BUT, W6FOH, W6ABF, W6FTR. There was a wonderfully high spirit of coöperation on the 1.7 mc. 'phone band—a member of the network would but have to give any station a short call and the operator would come right back "ready to render any form of service within his power." Congratulations to all concerned.

The following contribution by Mr. Merrill Peoples, W7WR, wins the C.D. article contest prize for this month. Your articles on any phase of amateur communication activity are likewise solicited and may win you a bound Handbook, or three logs, or message pads (see announcement page 56, March 1933 QST. Send yours today.—F. E. H.

## Accuracy!

By Merrill Peoples, W7WR \*

WITHIN a short time after I first went on the air, I began to handle traffic. Besides having an inclination toward that branch of amateur activity, my location, a small town on the Oregon coast—seemed a natural relay point between California and the Pacific Northwest. Hours and hours were spent relaying but my report on messages delivered was as small as an electron's eyebrow. After herding a flock of messages to their home roost, I'd often gaze eastward over the Coast Range Mountains and wish that I could be on the receiving end. What a cinch to deliver messages, to talk with interesting people, to explain and promote Amateur Radio—!

The opportunity came sooner than expected. In 1929 we moved to Portland but the end of the rainbow proved not so golden. True, I was fortunate to connect with an active traffic net and my delivery total mounted steadily. So did my grief.

\* 1637 N. E. Alberta St., Portland, Oregon.

I found the percentage of *inaccurate and incomplete* messages surprisingly high. In delivering, one finds inaccurate names and addresses that require research into the ancient and modern archives of your city. You become so well acquainted with the telephone company's information operator that you call her sister. What she calls you isn't spoken above a whisper! After completing the connection to a few addressees and spending one minute reading each message and nine more minutes "explaining and promoting" Amateur Radio, the remaining "no phone" traffic is forwarded via Uncle Sam's uniformed, paid message carriers. Is your job finished? No! Cards come back, embellished, "no such address." There are service messages to be sent to explain to those originating messages.

The one sure remedy for this deplorable situation is ACCURACY—ALL ALONG THE LINE. This is a matter of individual and personal responsibility. The relay man should watch himself constantly because he has two chances, on each message, to make an error. The originating and receiving operator must, of course, exert equal care in transmitting and copying. It is all too easy to originate a message with an incomplete address, to let the delivering operator do the worrying. It saves time, when in doubt, to quickly O.K. messages and take a chance that one's guess is right. But this doesn't spell accuracy.

I do not mean to imply that all messages are so difficult to deliver. Occasionally one comes through with complete preamble, correct name, phone number, street address, city and state, a snappy, important text, a full signature, and is, altogether, a delight to a weary soul. There is a bright side to the picture, too. I've made interesting, lasting friendships. One kindly lady offered to purchase any piece of radio apparatus my heart desired. (F. R. C. please note I said, "No, thanks just the same.") Also, I prize most highly the file of letters and cards bearing thanks for services rendered. But ACCURACY would make my service easier to render!

## Short Wave Listeners—Attention!

THE Bell System Radio Telephone Stations operated by A. T. & T. Long Lines Dept., municipal police radio stations, and Airways telephone stations are Public Service and point to point fixed service (not broadcasting) stations. These stations are not largely interested in listener reports and as a rule do not "QSL" or verify your reception of transmissions. This means that most such reports are not wanted, and will not be "checked" and in many cases, not even acknowledged. These stations all sign their calls at half-hourly (or more frequent) intervals and may be then identified by reference to a suitable call list.

The laws of the United States and the International Radio Convention impose upon chance intercepting listeners, a very strict obligation of secrecy with respect to business handled by such stations. Severe penalties (heavy fines and/or imprisonment) may be imposed for violation of this obligation. Under no circumstances may information obtained by listeners to such services or to any specifically addressed transmissions (except broadcast) be used in any manner by the listener, or divulged to unauthorized persons. "All persons who may have knowledge of the text or simply of the existence of radio telegrams, or of any information whatever, obtained by means of the radio service, shall be bound to maintain and insure the secrecy of correspondence.

## O. B. S.

THE following is a supplement to the list of A.R.R.L. Official Broadcasting Stations in November QST (page 51):

W1DMI, W3BTM, W5BZT, W8FGV, W9DBO, W9JBA, W9LWK.

## Routing Traffic Reliably

By Harry E. Legler\*

IT HAS been only recently that I have taken to traffic handling in earnest, the result being my appointment as O.R.S. Schedules were established and traffic totals reported to the S.C.M. In my traffic work some deplorable practices were revealed to me. Messages turned up two weeks old and considerably off the route they should have taken. Stations were heard passing a message around a clique, running up the total for themselves. Without thought to "direction" messages were handed along just to keep them going. Dates on traffic indicated the speed of our service not all it should be. When we originate a message for an uninitiated sender, he oftentimes has the idea that our radio system will get it through in good time. He later may hear, however, that the message was received by the addressee, but long after he expected it to be.

Our trunk lines and our five point schedule system are fine and they do move traffic. But A.R.R.L. monthly traffic totals continually show a percent of messages originated but never delivered. Some that are delivered are relayed too many times.

Recently I took a message from a trunk line station that had been originated in an eastern state and addressed to a town in Kansas. The station I took it from was closer to the destination than I was. I did not know it at the time and he probably did not know it either. I took it because it was traffic. He sent it to me because it went to my state, he being just at the eastern edge of the state. Somehow, I had the impression that the destination was in the central part of the state. Having no schedule soon with anyone in the state, I expected to put the message nearer home by calling CQ Kansas. An answer was received but from southeastern Kansas. I made use of the contact by hurriedly originating one for a friend who lived in this town. Later I passed the waiting message to another station located nearer where I thought it went. I then looked the location up on a map. It took time to find it, even with the locating key to the map and a state list of towns. To my surprise the location worked was in southeastern Kansas also, only 20 miles from the place just worked. A quick and simple method of looking up locations would have placed the message very close to its destination and saved much time. But a map that does not show all the out-of-the-way places is quite often useless. Something that lists all towns, large and small, is needed. Such a list is available to everyone and is none other than the United States Official Postal Guide. It lists every postoffice in existence.

The United States Official Postal Guide including postal rates and parcel post information is revised annually in July and placed on sale about September 1st. The Guide contains three complete lists of post offices, arranged one by states, one alphabetically, and one by states and counties. Cloth bound copy is \$1.50 from Superintendent of Documents, Government Printing Office, Washington, D. C. THE LIST OF POST OFFICES BY STATES IS ARRANGED AS A PARCEL POST GUIDE, THE UNIT NUMBER OF EACH OFFICE BEING GIVEN AND SPACE PROVIDED FOR THE INSERTION OF THE ZONE NUMBER. This is the list we are most interested in. This Guide is the only Parcel Post Guide now published by the Government. Separate Parcel Post Guide and Parcel Post Maps have been discontinued. The maps have been superseded by Zone Keys, these being furnished with the Guide.

Postal Guides and monthly supplements (50¢ a year from Washington) are furnished every post office annually, the old ones being replaced with the new ones. Old Guides are kept on file and, I believe, may be obtained gratis if it can be shown good use will be made of them. Paper covered abridged edition copies do not contain the alphabetical list but do contain the State lists of postoffices which is what we want.

To use the Postal Guide turn to the state lists. This gives each official postoffice number, then the postoffice, the county it is located in, the zone unit number of the office

\*W9PB-W9JSB, ORS, U. S. N. R., Hlawatha, Kansas.

and a blank space for entering the parcel post zone number for a particular office. The zone unit number is what we can use very handily. This number indicates the zone unit the office is located in. The old parcel post map of the United States was divided into squares (30 x 30 miles) each unit one half degree longitude wide and one half degree latitude long. Beginning at the Canadian border these squares were numbered in rows 1, 50, 100, 150, and so on, from east to west, with two additional digits (identifying north to south squares) making four figure identifying numbers for each square. All offices located in each unit will have that unit number after it in the Guide. To find where a town is located, look up its unit number, look at the map, find the row beginning with that number, then look down the row to the unit number. It will quickly locate your town within 15 miles anywhere on the map. These maps have been discontinued by the Postoffice Department with instructions that any left on hand be destroyed, but I located such a map and can furnish copies for each A.R.R.L. Division.<sup>1</sup> We can see where such a simple method of locating any town on the map would have helped me in placing that message in southeastern Kansas. The message got to Kansas<sup>2</sup> all right but had a hard time in getting to the right part of the state. This happens very often. Local deliveries often take more time than the "long hops."<sup>3</sup> Use of the Postal Guide can help perfect each relay route!

With the numbered square map and Uncle Sam's Postal Guide, the general location of any city or town having any class of postoffice can be speedily determined to facilitate correct relaying of traffic. A second method uses the Postal Guide to identify the county in which a desired addressee is located, and of course a map or atlas showing counties in your Section and Division is really necessary to use this plan effectively. The "numbered unit" system using the map will save you time and enable you to route all traffic intelligently.

<sup>1</sup> Official Relay Station appointees, A.R.R.L. Directors, Section Managers, and Route Managers can obtain copies of the parcel post map showing unit numbers by sending 50¢ to the writer. Specify which Division map is wanted.

<sup>2</sup> Time might be saved in looking up unit numbers if originating stations would include this in the addresses of messages, as for example: Hlawatha 2919 Kansas.

## Ramah (WCEN) Off for Transatlantic Cruise

THE schooner *Ramah* is scheduled to leave Hyannisport, Mass., June 21st at 2.30 a.m. bound for Mediterranean waters via the Azores and Cadiz. The party expects to reach Naples between July 25th and August 1st. Ed Brooks of WITL plans to schedule 3.5 and possibly 7 mc. hams from WCEN using 5530 kc. and the transmitter used at WCEN on the Forbes Greenland Expedition which has been remodeled. Another frequency (approx. 6200 kc.) may be used for communication with U. S. amateurs at the greater distances.

At present writing a 7 p.m. E.S.T. schedule between WCEN and WIMK is being planned and it is hoped that much general ham work will be possible with amateurs equipped to receive the 5530- and 6200-kc. frequencies.

### ARCTIC EXPEDITION

During July and August A. Dutilly, VE2GV, of the Institut Agricole, La Trappe, P. Q., Canada, will accompany a scientific expedition to the Arctic. He plans to transmit regularly from the Arctic Archipelago. Co-operation may be requested in handling traffic for this expedition from remote northern points. Watch for VE2GV.

## July 15th-31st VE3XB Contest Open to All Canadian Amateurs

A SPECIAL contest with prizes aggregating over \$200 value, delivered free to any part of Canada is open to all Canadian amateurs. The contest awards will be divided into two groups of prizes, one for c.w. telegraph contestants



and one for 'phone amateurs. The contest starts at noon 12.00 m. E.S.T. July 15th, and ends at 11.59 p.m. E.S.T. July 31st. All QSOs must be confirmed by each contestant sending in his log. Logs will be checked against each other. Unconfirmed contacts will not be counted. To insure logs being submitted a small prize will be given every contestant sending a report. VE3XB will not be in the contest but is eligible for scoring by a contacting party. Scores will be given logs as follows for all "confirmed" contacts:

- A QSO in the same district..... 5 points
- A QSO in the adjoining district..... 10 points
- A QSO two districts away..... 20 points
- A QSO three districts away..... 40 points
- A QSO four districts away..... 60 points
- A QSO five districts away..... 80 points

All frequency bands for which a Canadian amateur station is licensed may be used in making QSOs. All entrants will receive some prize. Send logs of QSOs to VE3XB, 355 Danforth Ave., Toronto, Ontario, Canada.

The Louisiana Section is holding a QSO-QSP Contest starting June 15th and ending August 15th. Scoring will be one point for each QSO, two points for each message sent, and two points for each message received. The SCM, W. J. Wilkinson, W5WF, is offering a prize of a one year's subscription to QST. Participants must report to the SCM on the 15th of July and on the 15th of August — failure to report is grounds for disqualification.

## Highest Scores—April O.R.S. QSO Party

Call	Score	ORS QSOS (4)	OTR ORS HRD (1)	Sections Wkd
W9AUH	31,654	139	90	48
W9YB	19,320	98	68	42
W4ZH	18,737	103	45	41
W4NC	16,068	91	48	39
W3LA	13,195	84	41	35
W9KKG	10,048	73	22	32
W8CJJ	8451	52	105	27
W8DES	8325	64	77	25
W1DNC	7824	43	154	24
W1YU	7587	61	37	27
W1CJD	7364	51	59	28
(2 ops)				
W1EOF	7263	60	29	27
W9VS	7072	54	56	23
W4R	6888	51	42	23
W6BSV	6276	52	9	28

Over 600 O.R.S. (by actual count of heard-and-worked lists) took part in the April QSO Party. "Fine operators." "The best time I ever had on the air." "Swell fists." "Enjoyed party. Many new friendships made." "Thoroughly enjoyed myself. Lots of fun even with low score." "QSP tlc. for four non-O.R.S. besides; nertz on points when O.R.S.-duty calls." "A most interesting part of being O.R.S." "Great sportsmanship; it spoke most highly of character of O.R.S. at W4BOZ to help his rival W4BBT add the R. I. Section to his list." These and many similar comments are typical of the spirit of the occasion.

### JULY 22nd-23rd ANNOUNCEMENT—FOR O.R.S.

The next quarterly QSO contest, for O.R.S. appointees only, is scheduled for July 22nd/23rd, with another to follow October 21/22.

The official O.R.S. list will be mailed to all appointees just before the dates of each contest period. Non-O.R.S. may make application for appointment by writing the proper S.C.M. (See page 5, this issue QST for address.) The qualifications for O.R.S. appointment are indicated in the Rules and Regulations of the A.R.R.L. Coms. Dep't which will be sent on receipt of a postal requesting same.

## BRASS POUNDERS' LEAGUE

(April 16th-May 15th)

Call	Orig.	Del.	Del.	Total
W3CXL	546	317	1597	2460
W8SN	473	302	1048	1823
W6PQ	715	297	568	1580
W6ETL	138	184	836	1258
W5EWQ	265	152	630	1047
W8AWX	180	154	673	1007
W9KG	9	63	910	982
W6BMC	57	72	806	935
W5BMT	165	185	584	934
W8DZ	100	82	741	923
W3AQN	253	158	472	883
W9ESA	14	102	756	872
W6TI	120	250	500	870
W8JE	147	98	562	807
W3ALX	216	124	437	777
W8BWL	199	179	397	775
W6CDA	9	42	722	773
W6EFC	97	47	590	734
W6EDW	174	140	409	723
K6GUA	506	45	172	723
W6ALU	135	174	408	717
W8FTW	33	20	653	706
W9AET	116	54	532	702
W2BKM	51	7	620	678
W7KL	37	44	572	653
W6CKO	83	124	434	641
W7AWH	94	87	438	619
W6DFJ	418	82	117	617
W8BHU	153	135	298	586
W7IG	57	66	452	575
W8GCJ	—	60	506	566
W6BPU	74	167	321	562
W9HGG	75	46	428	549
W5CEZ	130	131	426	527
W9EYN	21	107	408	536
KALLG	167	113	254	534
W3OK	78	81	369	528
W2ADQ	224	299	3	526
W6PBK	103	101	318	522
W9YB	391	86	43	520
W8BH	80	60	373	513
W9ABE	102	140	266	508
OMITB	290	107	110	507
W3CXM	144	221	137	502

### MORE-THAN-ONE-OPERATOR STATIONS

KAIHR	206	198	612	1016
W5OW	158	132	725	1015
W9BNT	225	368	218	814
W3NT	50	72	650	772
W8BKQ	79	67	594	740
W1MK	56	171	406	633
W3BWT	126	121	384	631
W6HHM	49	104	446	599
W9USA	—	—	570	570

These stations "make" the BPL with totals of 500 or over. Many "rate" extra credit for one hundred or more deliveries. The following one-operator stations make the BPL for delivering 100 or more messages: the number of deliveries are as follows: Deliveries count!

W6HM, 251	W6NF, 124	W9DNZ, 104
W9BMA, 244	W9ACL, 123	W8FLA, 103
W9IDW, 198	W7ME, 117	W6NK, 103
W9EY, 168	W3CJS, 116	W5ASE, 102
W8EWJ, 167	W8JF, 112	W7ALJ, 102
W8EDG, 162	W9HJC, 110	W9CJR, 102
W3CL, 158	W8HGG, 110	W6CQM, 101
W8FTI, 142	W7CRH, 109	W5BDX, 101
W8HEE, 135	W6APM, 109	W3MCO, 100
W3EY, 129	W6BPL, 107	W8FX, 100
W2DBQ, 128	W7BSX, 106	
W6AZU, 126	W7DP, 106	More-than-one opr:
W6BSV, 124	W2CHK, 105	W9NP, 238
W7ABD, 124	W6RJ, 104	W2DTU, 170

A total of 500 or more, or just 100 or more deliveries will put you in line for a place in the B.P.L. Make more schedules with reliable stations. Take steps to handle the traffic that will qualify you for B.P.L. membership also.

## Traffic Briefs

### EMERGENCY WORK

A heavy snowfall in northern New England on April 12th and 13th crippled communication with Claremont, N. H., all circuits including telephone, telegraph, etc., being out. On the morning of the 13th W1ATJ at Claremont established communication with W1BII, Manchester, N. H., on 3500-kc. c.w. WIBAC assisted ATJ at the Claremont end, and W1IP and W1CME carried on with BII at Manchester. Much important emergency traffic was handled

for the telephone company as well as numerous press items for the *Claremont Daily Eagle*, and various other messages. Schedules were maintained for two days, up to the time that conditions began to clear. The storm caught WIATJ with the transmitting antenna on the ground but he and W1BAC got it in the clear. The local power company tied ATJ in with its emergency circuit to furnish the necessary juice. Telephone company officials were high in their praise of this emergency circuit.

In connection with the same storm of April 12th and 13th, WIASY, Springfield, Mass., was called upon to get a message through to the Western Union wire chief at Brattleboro, Vt. Being unable to get at his own key until late afternoon ASY turned the message over to W1EBE, who raised a fellow within ten miles of Brattleboro and QSP'ed. When WIASY finally got on the air he and W1BSJ worked in shifts, keeping the station on the air until the message was finally moved — to W1EMI, who got the message through to the wire chief. Credit also goes to the following for assistance rendered in moving this message: W1BVP, W1API, W1OF, W1CJD and W1BDI.

W1FI of Squantum, Mass., an employee of the New England Tel. & Tel. Co., has organized fellow employees who are also "hams" into an emergency net always at the company's disposal in times of need.

During the period following the severe tornado at Minden and Arcadia, Louisiana, in which about 60 to 75 persons were killed, amateurs in Shreveport and Minden furnished valuable communication to Barksdale Field military authorities, American Legion relief workers, and the *Shreveport Times*. A letter of appreciation from the City Editor of the *Times* lists the following for commendation: W5BZR, W5CW, W5BJA, W5BFB and W5CEN.

#### W9USA-W9USE

The Chicago 1933 World's Fair is now under way and operations at W9USA and W9USB have started in earnest. The World's Fair Radio Amateur Council, under the guidance of which amateur activities are conducted, has made application for the calls W9USC, W9USD, W9USE, W9USF, W9USG and W9USH to be used in connection with the four stationary transmitters and the portable 56-mc. transmitters. The Council's plans call for experimental as well as communication work.

W9USA-W9USB frequencies are as follows: In the 3500-kc. c.w. band — 3505, 3560, 3630-kc. In the 7000-kc. band — 7010, 7120, 7260-kc. In the 14000-kc. band — 14020, 14240-kc. In the 3900-kc. 'phone band — 3907, 3960, 3995-kc.

The transmitters are all encased within a wire fence to keep visitors from getting hurt or from fooling with the

adjustments. As a safety measure rubber mats are used to stand on while tuning the apparatus. The two operating tables, where the receiving is done, are surrounded by a partition, which has a wood base and glass top, thus enabling visitors to watch operations without disturbing the operators.

Ed Wilcox, W9DDE, is in charge of communications and is placing 'phone operation in the hands of a 'Phone Chief, and c.w. operation in the hands of a C.W. Chief. These Chiefs will be responsible for the operators under them. An extensive network is being planned and it is hoped that a list of scheduled stations and W9USA-W9USB operators will be available for August QST. W9CRT is working up an Illinois net to handle communications within the state.

#### WORLD SPEED CHAMPION TO BE SELECTED

According to word from the World's Fair Radio Amateur Council, the radio amateur code speed champion of the world will be selected at the convention to be held at the Fair August 3rd, 4th and 5th. Elimination contests will be held during the three days of the convention. The winners in the various classes will compete in the final contest for the world's amateur championship. A beautiful silver loving cup is being awarded by "A Century of Progress Exposition" as the grand prize. Other cups will be given winners in the various classes. Come on, you speed hounds, get in on this!

When you have traffic for Chicago during the period of the World's Fair call "CQ CHGO" between 9 p.m. and 1 a.m. C.S.T., and listen for replies between 7050 and 7100-kc. "QSP Chicago," an organization of amateurs united to handle "incoming" Chicago traffic, are ready to accept your messages during those hours. Or, if you work on 3500-kc., a group of North Side (Chicago) amateurs are also planning similar work for the 3500-kc. band, using the same name and message forms as QSP CHICAGO. This group will include W9OP, W9DDE, W9ECR and W9DRN.

The San Gabriel Valley Short Wave Club announces a general Ham picnic to be held from Saturday, July 1st to Tuesday, July 4th, at Crystal Lake, San Gabriel Canyon, California. All amateurs are cordially invited. Bring portables. There is no charge other than personal expenses.

#### REPORTS WANTED ON CTIKC

The Instituto Geofisico, Cumeada, Coimbra, Portugal, CTIKC requests reports on daily tests sent at 1500, 1800 and 2100 Greenwich on 7000-kc. Meteorological data are also sent from CTIKC on 7000-kc. at 1100 Greenwich daily, six or seven groups of five numbers each being used

### Relative Standings of the Ten Highest Sections—Apr.-May

Messages Per Station (25%)	Stations Reporting Traffic (25%)	Gain or Loss (Traffic Reports) (25%)	Traffic Total (25%)	Standing Based on Average of All Four Ratings %	Section Communications Manager
M.-D.-D. C. 422.3	Los Ang. (680)* 108	Wash. +17	Los Ang. 7918	Washington 52.5	Grube, W7RT
P. I. 237.9	Va. (150)* 82	N. C. +9	M.-D.-D. C. 6335	Los Angeles 50.	Martin, W6AAN
Ark. 231.	Mich. (624)* 77	Va. +8	E. Pa. 5810	M.-D.-D. C. 47.5	Ginsberg, W3NY
Hawaii 223.4	Wash. (374)* 75	Colo. +8	Ohio 5113	Virginia 42.5	Eubank, W3AAJ
E. Bay 162.9	Ohio (868)* 74	E. Mass. +7	Ore. 5014	Michigan 32.5	Conroy, W8DYH
Okla. 162.4	Ill. (890)* 51	R. I. +7	Mich. 4596	Ohio 32.5	Tummonds, W8BAH
Nev. 161.5	Ore. (260)* 45	Ind. +6	Wash. 3469	E. Penna. 30.	Wagenseller, W3GS
W. Pa. 157.3	Mo. (324)* 45	E. Pa. +6	W. Pa. 3461	N. Carolina 25.	Wright, W4AVT
S. Dak. 149.1	Ind. (329)* 44	U.-Wyo. +6	W. N. Y. 3426	Oregon 25.	Cummings, W7ABZ
E. Pa. 141.4	N. C. (150)* 42	W. Fla. +6	E. Bay 3422	Philippines 22.5	Thompson, KA1XA



WASHINGTON steps into the lead this month, closely followed by Los Angeles. L. A. is the only Section with over 100 traffic reports, but special credit is due Virginia for a new high of 82 reports—this is 54.6% of the total Virginia A.R.R.L. membership! The following Sections lead all other Sections in their Divisions, order of listing showing relative standing of their different Divisions: Eastern Pennsylvania, East Bay, Oregon, Ohio, Virginia and North Carolina (tied), Southern Minnesota, Oklahoma, Iowa, Colorado, Connecticut, N. Y. C.-L. I., Arkansas and Tennessee (tied), Alabama, British Columbia. During the April 16th-May 15th month, 1669 stations originated 31,363; delivered 27,563; relayed 63,498; total 122,424. (87.8% del.) (78. m.p.a.)

\* Section A.R.R.L. membership shown by ( ) % reporting traffic: Va. 54.6%, N. C. 30%, Wash. 20%, Ore. 17.3%, Los Ang. 15.9%, Mo. 13.9%, Ind. 13.4%, Mich. 12.3%, Ohio 8.5%, Ill. 5.7%.

according to the International Meteorological Code. Please report reception of CTIKC by postal direct to the Instituto Geofisico, giving complete information on signal strength, fading, atmosphere, wind, general weather, etc.

### XX6AR

P. S. Francis, VS6AR, and five other Naval officers will sail a twenty-five-ton yacht, *Tamoshan*, from Hongkong about the middle of June. The first stop will be at Japan, following which the party will proceed to the United States. The yacht is equipped with an auxiliary ham transmitter consisting of a '47 crystal oscillator driving a '46 amplifier fed by dynamotor. Receiver consists of '36 detector and pentode. The call XX6AR will be used on 7220-kc., 7250-kc., and 8570-kc. Most all listening will be on the amateur bands, and amateurs are requested to keep a lookout for XX6AR and assist with weather reports or any other information which may be needed.

### ATLANTIC DIVISION

**E**ASTERN PENNSYLVANIA — SCM, Jack Wagenseller, W3GS-BF—W3BKQ, OK, CL, BEY, W8FLA, W3AQN and ALX make the BPL. W8CFF is on 'phone. W3CHU joined A.A.R.S. W3AKB is going to rebuild. W3AAV is QRL U.S.N.R. W3AMR is back from college. W3NF reports via radiogram. W3BPX refinished shack. W3ADE was in ZAG contest. W8EOH is A.A.R.S. NCS. W9EWW, opr at W8CFL, finished school and left Section. W3AVI is rebuilding. Everything going FB at club stations W3BKQ, CUI, ZZAI and ABT. W3ABZ is ORS. W8ITS is in line for ORS. Following reported for first time: W8ASW, W3DIS, CUG, CHL, W8IWT, 1XC, BEV, DAV, W3HLG. Tnx, Oms. The Beacon Radio Amateurs report: W8BUK, BRT, VO, CNP, MR, CMW, BIJ, VF, ATR, BGD, BZC. W3BF is moving to better QRA.

Traffic: W3AHD 308 CHU 21 AKB 227 BKQ 740 TX 8 CL 450 AAV 124 AMR 18 OK 528 BEY 306 NF 46 CFG 2 BPX 10 ADE 84 ANZ 8 MR 2 AQN 883 AVI 2 ALX 777 CUI 74 BVX 1 ZZAI 98 AZF 37 ABT 99 MC 293 DIS 1 CJA 10 ABZ 243 BF 41 BUK 1 BRT 3 CNP 3 BIJ 5 ATR 4. W8CFF 3 INA 8 EOH 47 FLA 287 CFI 9 ASW 4 ITS 15.

MARYLAND-DELAWARE-DISTRICT OF COLUMBIA — SCM, Harry Ginsberg, W3NY, W3SN, W3BAK, RMs. W3BWT, Chief RM. The following clubs continue their activity. The Frederick A.R.A., the Washington R.C., the F.A.R.A., the Westminster A.R.C., Baltimore A.R.A., the Institute of Radio Conferees, the Delmarva R.C. District of Columbia: W3CXL and BWT make BPL. W3ASO does his share. W3DIM is new. W3NR has FB rig. W3AJL promises to help. W3CDQ reports new receiver. Maryland: W3SN reports Bob Fox is going on furlough. W3CJS BPLs on deliveries. W3CQS promises hamfest in September. W3BXX is active in A.A.R.S. W3CMS has been made ARMY NCS. W3CTD gets FB results. W3CDG is QRL farming. W3CZH helped W3CLH fix sked with his dad. W3AQL. W3WN is going strong on 56 mc. W3AFF is helping in local BC station. W3CVV is rebuilding for 7 and 14 mc. W3DG is testing his 56 mc. outfit. W3NY is QRL work. Delaware: W3BAK doesn't expect to handle much traffic till cool WX. W3CPG says 1750 kc. FB.

Traffic: W3CXL 2460 SN 1823 BWT 631 CJS 377 CQS 300 BXX 235 BAK 136 CMS 135 ASO 94 CTD 66 CDG 31 CZH 26 WU 9 CIZ 7 BHE 5.

SOUTHERN NEW JERSEY — SCM, Gedney M. Rigor, W3QL — New stations report to the SCM direct their activities cannot be given full consideration. Your cooperation with me is the only way I can cooperate with you. W3BYR is being heard on 3.5 mc. by his brother who is in Greece on a yacht. W3ADL sends in complete activities of Ocean City. W3AOV is new ORS. W3ARV resigned as RM. W3BTS has new 'phone ticket. W3DGF sends first report. W3AXU desires ORS. W3DAJ married. W3BLR claims he started "Hi ditte de dit" on 'phone. W3CNR is on 1.7 mc.

Traffic: W8BYM 6 CLQ 30 APV 41 AXU 3 CWL 21 BPT 27 DGF 2 AOV 13 BTS 5 ZI 60 BWR 3 AEJ 15

ADL 11 QL 7 GU 8 AKI 2 BYR 11 IS 2 AZZ 7 APN 60.

WESTERN NEW YORK — SCM, Don Farrell, W8DSP — W8AWX is star traffic man. W8JE is new ORS. W8DII has been on consistently. W8FDY has QTA'd most schedules. W8BWW keeps a bunch of schedules. W8BFF has schedules west into Mich. W8DHU reports conditions bad. W8DMJ is changing. W8GWT has three schedules. W8GWS rebuilt. W8BHK reports very FB 1.7 mc. 'phone work thru DSS and CPJ. W8FTB is getting along fine with A.A.R.S. W8DBX changed QRA. W8AFM is hard at convention duties. W8CDB has built a number of 56 mc. outfits: W8BJO was on RMNite. W8AOW has been hamming around the State. W8ECF and EBR turned in nice totals. W8CQW reports Jamestown Club busy on summer activities. W8FFU wants ORS. W8GWY moved to South Glens Falls. W8GPT reports new station, W8JJJ. W8JV worked a station on 14 mc. signing VQ22XNG. W8EBK sends first report. New officers in STTA are pres. W8DHQ, V.P. Carl Drakeley, secy., W8GWT. W8AKX is going to Camp Dix. W8ECY schedules W8JML. W8KF has S.S. completed, W8BAI, HNZ, DT, AIK, EBT and HNV have applied for portable licenses. W8DWW is back from his southern home. The Elmira Radio Amateur Association have a new method of checking up on illegally operated stations.

Traffic: W8AWX 1007 JE 807 DII 402 FDY 227 DSS 170 BWY 169 BFF 103 DHU 42 DMJ 40 GWT 34 GWS 29 BHK 14 FTB 10 DBX 9 DSP 6 AYU-BR-AGS 4 FMX-GWZ 3 ECF 81 CQW 27 FFU 22 EBR 19 GWY 18 GPT 15 JV 11 FYF 6 EBK 28 ECY 9 AVS 3.

WESTERN PENNSYLVANIA — SCM, C. H. Grosarth, W8CUG — W8BWL leads the gang. W8HEE, CQA and CPE are handling traffic for reforestation army. W8YA has a good total. W8EDG was active during A.A.R.S. contest. W8HGG has been appointed Route Manager after W8AJE resigned. W8GUX reports. W8CCD will have good total next month. W8KD is poking out. W8DNU reports organization of the Rocky Grove Amateur Radio Club in Franklin. W8FKU has been working. W8AVY is going back to 3.5 mc. W8CFR dug a hole for his pole. W8EHW reports for CMG, CCW, CRA and IKE. W8CUG is constructing.

Traffic: W8BWL 775 HEE 463 YA 403 CPE 382 EDG 263 HGG 222 CQA 210 CUG 169 AJE 136 FRA 104 GUX 86 DLD 62 CCD 60 AAQ 36 KD-DNV-CLG 17 DYF 14 AEG 12 CMP 7 GBC 5 AYQ 1.

### CENTRAL DIVISION

**I**LLINOIS — SCM, F. J. Hinds, W9APY-W9WR — RM W9CRT Forrest Wallace. RM W9DDE Ed Wilcox. W9HQH wants to know why we don't make all RM, SCM, OO, ORS and OBS use PDC on the air to set an example. W9IVF and IYA are at the same QRA but are two different stations. W9BIN uses a home-made automatic key. W9MNB applied for ORS. W9KIM now has a crystal. W9KEH is working on coast to coast net. W9FWD was heard by JIEG. W9AAY added band spread to the receiver. W9HMB and HKC are new additions to the World's Fair Nets. W9FXE works 14 mc. A new transmitter is nearly done at W9ERU. W9IEP was host to W9HMB, HKC, DBO and LNI. W9IUF is moving. W9ILY is getting warm on traffic. W9JZY will double with W9CRT this summer on W9USA traffic. Earthquake traffic at W9HMK. W9AYB has gone to c.c. 'phone on 14 mc. A new FB-X at W9AD. W9CZB sends first report for 16 months. A dandy new S.S. at W9CUH. W9AAW is managing the World Wide Radio Amateur Convention in Chicago August 3, 4 and 5. W9DDB says 7000 cannot compare to 3500. W9KOR is working on new house. W9GPK has an ambition to crash through to Los Angeles! W9FGV wants to know where all the traffic is. Transmitter trouble at W9CZL. W9ACU worked Spain, Ireland and England in one afternoon. A new stick at W9FO. W9MWO, MSG, MJB, MLF, LVQ, and MII are new reporters. A breakdown at W9FTX. Rebuilding at W9GZW.

Traffic: W9USA 570 DOU 379 JZY 323 CRT 221 ENH 137 ILY 132 ERU 93 KEH 87 DBO 86 IEP 84 HKC 77 HNK 75 MW 70 FCW 64 CGV 62 ACE 54 HMB 52 AMO 42 CZB 23 IYA 22 FXE 21 DZU-ILG 20 KIM 17 BPU

16 AD 15 CUH 14 EMN 13 IVF-MBJ 10 AVB-DJG 8 BIN-HQH-IGN-IUF 7 MNB 6 DGK 5 KA-MFL 4 HUU-HUX-ICP-IYP-LNV 3 BRX-LNI-MNV-SG-WR 2 CEO 1.

INDIANA — SCM, Arthur L. Braun, W9TE — W9AKJ is active as OO. W9AET makes BPL. W9APV is doing 56 mc. work. W9BTR reports for first time. W9BHM is planning on '52s. W9CKB is doing nicely with traffic. W9CWO is building c.c. rig. W9DHI keeps traffic schedules. W9DPL has trouble with receiver. W9DET uses a '45 in TNT. W9DJU is ready for traffic. W9EZR and AHL are rebuilding. W9ELX DX's. W9HPQ, EXL and JRK have good schedules. W9EPT worked QT4 and EAR. W9FQ is helping with the Ind. traffic net. W9FXM is on with 50 watter. W9FRY is building a.c. receiver. W9GNY is ready for RI. W9GGJ spent 100% of his time "calling." W9GFS was visited by W9BJZ of Colorado. W9HIU was heard by a ZL on 3.5 mc. W9HUV is new ORS. W9HML will have a YL op soon! W9JZA is a DXer. W9KGI has new receiver. W9MPB, MRR and MOK are new. W9MSZ is getting out. W9KJD moved to Richmond. W9KFS has p.d.c. W9KYM is QRL work. W9KZK uses '45s in PP. W9EBB uses c.c. W9FZQ sticks by his '45s. W9VW is QRL YLs. W9HGT is building 56 mc. rig. The Evansville Radio Club is now affiliated with A.R.R.L. W9HKB burnt out a power transformer. W9IMT is ready for Ind. World Fair net. W9JTU and HTP are going c.c. W9JLH is proud to be the only YL op in Indiana. W9JQJ is Comm. Mgr. at Ft. Wayne club. W9JRR rebuilt a cond. mike. W9KDD, AEO, DET graduated from High School. W9MM had 7 QSO's with K6. W9LLV is building a EC freq. meter. W9LCL is collecting parts. W9LOW's light bill went up! W9MYC is new ham. W9HKU has FB 'phone. W9RE is coming on with high power. W9CHA is building c.c. freq. meter. W9BWI visited Ft. Wayne club. W9HUO has moved. W9KPD is teaching his YL the code. W9LEI and ADL are planning 'phones. W9AMM is DXing. W9JKK joined the Forest Army. W9KZK is doing service work. W9HJ uses '03's in parallel. Kokomo Club is building a c.c. transmitter. St. Joe. Valley Club elected new officers: W9FBH pres.; W9LG vice-pres.; W9AKJ secy.; W9CFE treas. The ham having the highest traffic total for the 3 months starting June 15 at midnight and ending Sept. 15 at 11:59 p.m. will get a crystal donated by W9BKJ. Get in on this contest and win the rock. A second prize will also be given by the SCM.

Traffic: W9AET 702 YB 520 DHI 336 JOQ 166 IMT 154 GNY 119 HML 107 JRK 102 CKV 97 FQ 94 JIW 163 EPT 64 JHY 47 JTU 46 JRR 45 LLB 41 DHJ 19 EXL 38 AUT-MM 15 HUV 21 HPQ 19 DJU 14 FRY 13 EZR 6 GFS 7 JLE 10 BKJ-TE 7 AXH 6 FYB 3 CTT 4 DJJ-HKH 5 HIU 6 HTP 10 HBK 9 JVG 1 JQO-KDD-LYJ 3 QG 1 APV 6 LWK 30.

KENTUCKY — SCM, Carl L. Plumm, W9OX — W9BWJ takes the honors with BPL. W9OX moved to new location. W9ETT took over W1MK schedule. W9AQV livens up considerably. W9FEZ is building s.s. receiver. W9AUH handles traffic with K6VG on 3.5 mc. Wind flattens W9HAX's antenna. W9ARU-BZS-OX-CNE-JYO-KPI-HBQ-HCD-EQO are within a ¼ mile circle! — hurrah for Lam's s.s. Lightning scared W9BAN out of shack. W9CIM and KEG completed new transmitters. W9IFM wants state ORS club to meet on air. W9CDA is rebuilding. W9KTO is lined up for traffic work. W9MWR is new station in Lexington. W9JIX is building 14 mc. transmitter.

Traffic: W9BWJ 382 OX 211 ETT 132 AQV 120 FHZ 117 AUH 98 HAX 82 ARU 81 BAN 80 CIM 78 ONE 52 ERH 51 KKG 50 CDA-IFM 49 EQO 42 ELL 19 JYO 7 EYW 6 BAZ 5 JDI-KTO 4 HCD 12.

MICHIGAN — SCM, Kenneth F. Conroy, W8DYH — W8DZ holds the lead. W8FTW is second in traffic. W8EDO is calling his "teacher" by first name — Stella! W8EMC comes to life. W8CEU claims the Bull is the best paper in U.S.A.! W8BJ's transmitter does a loop! W8HBZ is at the lake with HNB. W8FX seeks a "radio-widow." W8AEQ and DPU report via W8DZ. W9DCN and W9HIS are knifing for W9GQF. W9FSK is Philco man. W8BMG lost his mother-in-law. Polly and OM W8DYH plan tour of Michigan in Sept. W8IOR tells of

radio 22 yrs ago! W8GUC schedules W8DZ, W3CXL, W9DOU. W8EVC plans on spending dough on things other than radio. What happened to W8EHD? W8QT, without W8BMG to back him up, falls by the wayside. W8CPY wants Peepin Tom to see if W8AKN is like that (!) with a Mary. W8DVC wants his ORS! W8EBQ says Marcell and Radio Waves don't mix. W8HSH radioed a steward's request for money — and in 36 hours said student had the "bux." W8IFO contributes one dime to a fund for a "Slowdownograph" for W9USA! W8IHN had to choose between YL or 83. W8IDB is another Detroit hot-cha. W8AYO hooked a bunch in A.A.R.S. ZAG contest. W9GQF tells of a certain well known Vagabond, sleeping on the grass at Minneapolis! W9BBP is doing a farm act! W8DLX hopes that cleaning wallpaper doesn't ruin his fist! W9CSI's new P.A. will be the Papa of 'em all! W8EUD knocks off loads of DX. W8SS is providing communication with W8CAU for an intercollegiate chess game. W8YQB is blown up with blonde-pressure. Report to W8DYG for copy of Bulletin with all dope.

Traffic: W8DZ 923 FTW 706 JF 322 FX 272 DUR 226 GUC 199 BJ 160 IDB 142 AEQ 131 EVC 119 AYO 109 CPY 104 CST 100 DVC 97 DLX 86 COW 67 CEU 46 ARR-EGI 43 DPU 40 ETP 28 IHN-NR 26 EMC 24 HUD 21 HOT 19 CFM-GDR-HKT 18 GQB-IFO-SH 17 JO 16 DSQ-HA 14 BMG-DYH-IFD-IOR 12 DED 10 EHD-HBZ 8 AW-GRN-SS 7 CUX 6 CPH-GRB 5 BBX-FAV-FCU-FVP 4 CTD-HSH 3 CRP-GUN 2 BJT-CUP-FWG-FXB-GSZ 1 AJL 6. W8CE 58 ADY 35 FSK 28 GQF 24 BBP 17 CEK 15 CST 10 DCN 5 IOV 4 DSJ-EVH-HSQ 2 IJH 15 LLD 2 CWR 1.

OHIO — SCM, Harry A. Tummonds, W8BAH — W8DDS Chief RM Ohio. The SCM would like a message from those reading this. District 1. RM W8BKM. New ham is W8JIO. W8GGF will be on this summer. W8EEZ is now ORS. District No. 9. W8GRG reports from Marietta. W8DPU may be RM of this district. District No. 4 RM W8EEQ. W8IEJ reports. A pair of '24s at W8EMK. W8FBC has portable IWE. W8ICC reports new Rucyrus Club, call W8JBL, meetings at Y.M.C.A. W8HMH and ANZ are new ORS. W8DEM is trying to raise dough to join A.R.R.L. W8WE reports HSI now in Mansfield. W8JU has new e.c. job operating. W8PO is now RM for all Ohio Portable work. His portable call is W8HSG. District No. 7 RM W8VP. W8EQB uses a doublet for receiving. W8CXC lost his antenna. District No. 6 RM W8BBH. W8ISK will be ORS soon. W8GDC is moving to new Q.R.A. W8HTI is building new receiver. W8GCG says 11 new hams in Springfield. W8DKE's report was sent by W8GCI. W8GSO announces new club. The Lancaster Amateur Radio Assn., W8FEQ pres., W8DGT secy., W8FEQ Jr. treas., with W8NG, HDF, DZO, GSO, BLE as charter members. W8EEY is putting in a 511. W8EWR sends nice total. District No. 8 RM W8CSG. W8IDY reports for Queen City Radio Amateurs of Cincinnati. "Daytime DX good on 7 mc.," says W8EDY. New zepp going up at W8BKE. District No. 5 RM W8FGV. W8FDV is awaiting good weather. W8BKR reports by radio. W8GER at Dayton is A.R.R.L. QSL Mgr. The five year old '52 at W8BSR is no more. District No. 3 RM W8APC. W8BZD is on WADI, Str. W. A. Reiss. W8GOD says new ham at Dresher, W8JGZ. W8IUG has stepped up power on '03A. W8GBG and EHZ report. W8ARF reports for the Maumee Valley Radio Assn. District No. 1 RM W8DVL. New rig at W8GKF. W8HPW reports 1% on traffic. Best DX for W8ACZ is Netherlands. W8ZZB is getting ready for contest. W8FFK and GLL report. W8BMK has spring fever. C.c. rig at W8AOJ. No schedules at W8BYD. W8BMX has more time for traffic. New a.c. receiver at W8GVL. W8AUM is now ORS. W8IJR applies for ORS. W8GQU wants schedules. W8GKG made 1200 points in A.A.R.S. Contest. W8EBY wants to go to Chicago. W8AIR has been handling lot of traffic. W8DDS has some old time schedules working sick. W8BRB is getting ready for portable tests. W8FJX is on Str. John Reiss, KUTM. W8HUS is rebuilding. W8HCP is now in Cleveland. W8RN is on Str. J. H. Sheadle, KKUI. W1BZD is now W8JGE.

Traffic: W8GCJ 566 BBH 513 PO 423 FGV 390 EEQ 380 BAH 348 DDS 306 GOD 258 EEZ 238 BKM 210 DVL 112 APC 126 WE 78 EBY 77 AIR 70 UW 153 EWR 65 HEY 51 EQB 49 GKG 48 GLI 40 BKR 39 DKE 26 DEM 44 GQU 29 GSO-IJR 24 ANZ-AUM 23 DUV 22 GVL 20 BMX 18 HMH-GBG 16 ECR 21 ICC-BYD 16 HTI 15 FBC-BZD-EMK-BKE 13 ESN 11 A0J-EDY 10 BMK 9 GDC-ISK-ACZ-ZZB 8 FFK-EHZ 7 FDU-FJE-HPW-VP-IEJ-BAC-GKF 6 EJA 5 GJS 3 ELP-ARF-EVS 2 UX-DIE-FNX 4 CXF-HVW-DXR 3 CGS 2 EFV-DVI-EPP 1.

WISCONSIN — SCM, Harold H. Kurth, W9FSS — W9HGG led the state. W9ARE is sailing. W9DRO moved. W9HFA is redecorating shack. W9IZU swaps station 'photos. W9IZZ is 56 mc. enthusiast. W9ECP is looking for DX on 14 mc. W9ESE needs parts for his 56 mc. rig. W9HKL renews subscription to "QRZ." W9GVF has S.S. going FB. W9FXH is still hunting bugs. W9BJF is in Montana. W9BQM is visiting his brother — W9CID. W9DJA is back to work. W9IGH has new sky wire. W9KTK is in love at last. W9ETN is at Wisc. Rapids. W9FTH sings praises of new 58 receiver. W9JCW needs new receiver. W9HVA and HRM are new ORS. W9JZU is building c.c. rig. W9HSK was sick with flu. W9BTA works W9AUX on 56 mc. W9ACK expects to go on 1.7 mc. 'phone. W9IDG is awaiting ticket. W9KLL and HVB are sailing. W9FSS passed extra first ham license. W9NAV is new ham. W9EYX moved out to lake for summer. W9CZX is going to radio school. W9HOM has 1 KW tube for sale. W9DTK is QRL Naval Reserve. W9AFZ is enjoying summer vacation. W9LAD enjoyed M.R.A.C. QSO Party.

Traffic: W9HGG 549 IYL 277 AON 243 GPQ 215 FSS 209 HTZ 191 AUX 149 HMS 138 BXM 112 GWK 98 IUC 86 DXV 80 KJR 73 GFC 55 LEC 54 VAG 40 HRM 138 IQW 38 HVA 25 BQM 21 KTN 22 ESZ 17 DNU 14 JDP 13 IBY 12 DZZ 10 KPK 2 ZY 20 AZN 5 HSK 56.

#### DAKOTA DIVISION

NORTH DAKOTA — SCM, Wm. A. Langer, W9DGS-IFW — W9BPM celebrated Engineer's Day. W9AZV reports the stork's arrival for W9DM. W9EVQ is busy gardening. W9FTV is QRL. W9DYA and JAR took Amateur exam. W9KBE handled traffic for Boy Scout executive. W9EGI reports a QSL from OMITB. W9B7J reports a newcomer, M9MZE. W9BMR has new c.c. rig on 7 mc. W9EJC attended the convention. W9CBM and DGS are working on power supply for portable rigs.

Traffic: W9DGS 371 EJC 342 AZV 104 EVQ 100 DM 60 FIV 54 DYA 36 KBE 27 EGI 14 BTJ 7.

SOUTH DAKOTA — SCM, Carroll B. Miller, W9DKL-GIO — W9FOQ leaves for the Century of Progress June 23. W9HAT will be on 7 mc. c.w. and 14-mc. 'phone. W9IQZ has c.c. on 3600 kc. W9CFU received portable call. W9MVQ. W9BAE moved to North Platte, Nebr. W9FLO is on 56 mc. W9IEK is preparing for unlimited Exams. It never fails to rain on the Sioux Falls Radio Club picnic day, says W9ALO. W9GPB, KPQ, DJN, and GQH were visitors at W9DKL. W9AZR will build a new 50 watt rig. W9IDW is rebuilding to c.c. W9GIO is DKL's portable. W9DGR reports traffic.

Traffic: W9IDW 450 DKL 267 HAT 124 IQZ 106 DGR 83 IEK 69 FOQ 62 ALO 32.

NORTHERN MINNESOTA — SCM, Palmer Andersen, W9DOQ — W9IPN has portable KUE. W9BRA received commission as Ensign in U.S.N.R. W9AKM wants Aeronautical ticket. W9ISA is rebuilding. W9DOQ has a new transmitter. W9JIE acquired a Comet Pro. W9LFO gets a kick out of ham traffic. W9HNS handled 43 while in the hospital. W9DJW hopes the Dakota Division has many more conventions. W9IAE says bad radio weather. W9BVI has been laying off DX. W9FTJ is going to 14 mc. W9AEL had a big time in A.A.R.S. contest. W9IPA is coming on with c.c. W9CDV and FNQ say "73." W9BHH is doing relief operating for Northwest Airways. The Arrowhead Amateur Radio Club enjoyed Director Lindsmith's report after returning from Hartford.

Traffic: W9HDN 71 FNQ 26 JIE 50 IPN 31 BRA 79 LFO 30 HNS 43 IAA 5V 26 AEL 61 IPA 15.

SOUTHERN MINNESOTA — SCM, Norman Beck, W9EPJ-CGR — W9BN and BHZ worked NY1AA. W9CSY is organizing a 28 mc. network in the Cities. W9BKY is QRL. W9LN has new antenna. W9YC handled electrical show traffic. W9BNN has portable MKA. W9JID leaves us for Northern Minnesota Section. W9EYS's new c.c. rig is ready to go. W9CSU and DH had great time at Convention. W9EPJ is QRL business. W9DRG and JBA blew rectifiers. W9JEQ has new crystal. W9BKK has cur license 39-866. W9CPP keeps two schedules. W9GCN wants ORS. W9GLE is QRL tropical fish. W9KDI and IDF are almost twins. W9DEI goes back to Milwaukee to finish school. W9JQA applies for portable. W9DGE is busy on river. W9LDQ put seventh patch in sky-wire. W9FMA deserts us for No. Minn. forests. W9HZU puts up new radiators. W9DRK, EZJ and TI have a tri-corner 56 mc. net. W9BGG takes 'photos by ultra-high-frequency. Minneapolis gang, get ORS reporting cards from W9LN. Wisconsin beat us in contest.

Traffic: W9BN 446 CSY 402 BKK 346 LN 336 YC 289 AIR 224 BNN 215 JID 158 EYS 112 CSU 88 DH-EPJ 82 DRG 70 JEQ 50 BKK 47 CPP 30 GCN 25 GLE 22 BHZ 21 KDI 18 JBA 17 DEI 6 JQA-DGE-LDQ 2.

#### DELTA DIVISION

ARKANSAS — SCM, Henry E. Velte, W5ABI — W5BMI leads the state in traffic. W5JK ran up nice total in ZAG Contest. W5AAJ reported by radio. W5BED moved to Gentry. W5DFM is a new station in Gentry. W5CSQ has joined us from Oklahoma. W5IQ has his transmitter mounted on rollers. W5BXM is getting SW3. W5CCW went c.c. W5CR is QRL school. W5CSN is announcer at KUOA. W5BTX is getting ready for Class "B" 'phone. W5PX is on two trunk lines east and west.

Traffic: W5BMI 934 IQ 271 AAJ 201 BED 126 PX 120 JK 108 ABI 78 CSQ 12.

LOUISIANA — SCM, W. J. Wilkinson, Jr., W5WF — W5QJ is QRL work. W5AFW and AYZ are going strong. W5BJA took unto himself a wife. W5BYY is on occasionally. W5KC will take part in Field Day. W5BID says Bootleg liquor good for cleaning crystals. W5CXQ is ex-5BDY. W5BZR handled tornado traffic. W5EB gets out well. W5CEN is rebuilding. W5DBW is new station. W5FR is on all bands. W5ACA, AXS and BS are active. W5PY has c.c. W5CRE is in Shreveport. W5BFB and AOO are building c.c. rigs. W5BN and ZK are in A.A.R.S. W5AKW will be home for summer. W5BSR will operate W5CUZ at Scout Camp in July; freqs. 3647 and 7294 kc.

Traffic: W5AFW 91 WF 63 BZR 20 AOO 7 BID-KC 6 AYZ 4.

TENNESSEE — SCM, F. F. Purdy, W4AFM — Mrs. Rooie Campbell (W4FPF's XYL) of Johnson City is the first OW operator in the state. During the Army-Amateur ZAG contest, W4AEP scooped the highest score in the Fourth Corps Area. W4OI has a dandy U.S.N.R. Net going in and around Memphis. The second issue of the State Bulletin, "Back-Waves," was received very enthusiastically. All it takes to get on the mailing list is a monthly report of station activities. These reports are due the 16th of each month, so if you want a copy of the bulletin, get busy. W4BOZ is the Alt. SNCS for A.A.R.S. W4AAO joined the Reforestation project. W4PL is in Florida. W4MU is becoming nationally known on radio-telephone channels. W4FK, AZM, BOZ, KA, LU, MU, OV and AAD are active on the 'phone band. W4LC has taken on a "Badder" half. W4AXN is praying for bigger and thinner Beer Bottle. New stations heard from: W4CGS, JG, AJJ, HL, ALO, BXQ, AYE, AFI, AZM, ZP, CBU, BXP, BWJ. The only power available to W4CBU is a couple of "Ford" spark coils. A hard wind scattered W4HA's mast over half of Springfield. W4RO is QRL work. W4ZZ QSO'd VP4TB. W4PL was heard in New Zealand on 3.5 mc. W4LU is warming up for some summer "Guzzalation" tests. W4ACU will be back on 'phone soon.

Traffic: W4AEP 397 AFM 227 HA 172 RO 91 JG 88 APT 74 AFK 50 PL 52 AYW 50 EX 47 BOZ-AAD 38 OV 21 AJJ 14 BUD 12 BUX 11 AZM 8 BUC 7 ZP 6 BXG 3 ZZ-CBS-BDZ 2 BQK 3.

## HUDSON DIVISION

**E**ASTERN NEW YORK — SCM, R. E. Haight, W2LU — W2BJA is the "Star Traffic Handler." W2ATM joined U.S.N.R. W2UL enjoyed active duty at Floyd Bennett Field. W2DTB says all boys in his city going strong. W2QY has fine luck receiving DX on 56 mc. from fire tower. W2CBN puts thru FB QSP for Albany for SCM. W2EGF reports new Champ CQer. 93 continuous CQs with only 6 signs! W2SZ QSOed with airplane during RPI House Day. New antenna at W2ENY. W2KW is open for inspection. W2CJS reports an article, "Some Observations on Operating and Procedure," by RM W2BJA, read at A.A.R.A. meeting. W2FEN is new ham. W2DVY is enjoying 56 mc. W2DWO reports on activities of MidHudson Amateur Radio Club. W2EDT deserts ham radio turning to YLing. W2AXX and W2DOS are QRL at Vassar College. W2CGT and DWO are ready for CMT.C. W2BAF is new member in club. W2AEQ had 100% QSO with Africa. W2AMM joins 14-mc. phones.

Traffic: W2BJA 202 LU 136 ATM 89 UL 77 DTB 64 QY-CBN 31 EGF-ENY 14 KW 12 CJS 10 DDW 8 BLL-CJP 5.

**N**EW YORK CITY AND LONG ISLAND — SCM, E. L. Baunach, W2AZV — W2DBQ and CHK send FB reports. W2BPJ has his transmitter locked up in the closet. W2CCD has decided to go back to 7 mc. W2BAS received card from Germany. W2EYU reports two new hams, FTB and FNU. We have a new YL, W2FBL. W2BNJ can be heard on 3550 kc. W2DRG reports from Ohio. W2AAK and ASG have gone in for ham station photographers. W2AGL and CYX operate in the morning. The BCLs have threatened to cut W2AWT's ant. down. W2BEG lost ten pounds during the Board of Directors' meeting! W2DUP is trying 1975 kc. 'phone. W2BMH's portable is FDT. W2COH is one appendix less. W2FIS and ETZ send first reports. W2UK goes in for Tennis. W2EYS and EYQ are out for ORS. W2CEH has been bitten by the 1750 kc. bug. W2BSR is still working DX. W2EBT is using single pentode crystal oscillator. W2EXO is looking for schedules. W2TI is making vest pocket 56 mc. rigs. W2AOC can be heard on 1.7-mc. 'phone. W2DLE is on with flea power '01A. W2AIQ made high score in A.A.R.S. contest. W2CBB handled his traffic in 3 weeks. W2ELB is awaiting his QSLs from VE's. W2AZV and DTT are looking for European schedules.

Traffic: W2ADQ 526 DBQ 334 CHK 256 DQW 123 CBB 104 AIQ 89 BNJ 59 ELB 51 AZV 48 BPT 46 CYX 42 CCD 26 AGL 20 EYQ 31 BAS 18 DUP 14 AWT 12 EBT 8 EYS 10 BMH 5 ETZ-EGA 4 DOG-DBE-AAK-EYU 3 CLM-AGC 2.

**N**ORTHERN NEW JERSEY — SCM, Walter A. Cobb, W2CO — W2EKM is high man for first time! The SCM gave talks before the Passaic County and Rutherford clubs. W2DSV has portable FRX. W2ELJ and ETQ are ORS, with BXM and BWZ on waiting list. 1.7-mc. 'phone net of 15 stations includes: W2DZM, EBZ, BXM, ERK, EOY, EQS, DAC, AVQ, CTV, W3CNS and CVZ. W2DPA wants good morning schedules. W2CJX spent time while sick designing new rig. W2CIM announces opening of new cellar shack. Wet WX annoys W2AMR. W2CIZ is going to try balancing act on edge of 3.5 mc. band. W2EJF is slated for C.M.T.C. camp. W2ABT built new super. W2BPW is QRL college. W2EGT is c.c. W2BXA gets on some. W2DJY is teaching YL the code. W2APW is on 1.7-mc. 'phone. W2BIJ is back after recent accident. W2EQQ is ping-pong champ. W6CYY favors the Newark bunch with his presence. W2ALD is portable FK.M. Officers of Rutherford Club: W2EWU, pres.; CDG, vice-pres.; CIM, secy.; DPB, treas.; DRA, corr. secy. Helmetta boasts 4 active hams, W2SN, District QSL Manager, DGU, FKU and FGM. W2TX complains that the postoffice is using him as Montclair QSL distributor. W2CHH disapproves of self-excited rigs. New hams: W2FDL, FOW, FRD, ADA, BYG, FCB, FNR. First reporter: W2CTT. W2BTT is enjoying himself in Ecuador. W2CEC schedules HC2RL. W2DBY hopes to get his outfit working right. W2CNW put up a new mast. W2BHN feels the yen for a crack at unlimited 'phone

exam. W2DRN will move to summer quarters. The boy with the meanest bug in Paterson is W2BRY. W2FEA tried to cash a National Guard pay check during the bank moratorium! W2DOV wants to dispose of his 211. W2EEC admitted his one-tube super was impractical. W2DNX enjoys high school. W2FAF is on 3.5 mc. W2EYE has no luck with DX. W2GFV QSOed his first EAR. W2GFX blossomed out with new crystal. W2FLU is a one-man epidemic over in East Paterson. W2DEE has portable FCL. W2FFM has started work from Hawthorne. W2EIC has no difficulty keeping his mike transformer cool during operation, it being a five-kilowatt pole unit! W2CZP has new SS receiver. 14 mc. MOPA has W2DFB bluffed. W2BYK got by the 'phone exam. Craig Harvey of Asbury Park has portable W2FOR. W2DMU plays around on 1.7 mc. W2BYR boasts of his new outfit. W2ABX has been unable to complete his projected c.c. unit. W2BLQ is sporting portable FNX. W2EQS rates portable FDC. W2DNR and BOY spend most of their time on 3.5 mc. W2BPY works 1.7-mc. 'phone. Bloomfield Radio Club intends to hold 28 mc. party in Sussex County first weekend in June.

Traffic: W2DIU 345 BPY 149 TP 50 CIZ 27 EIC 21 CGG 20 AMR 19 CJX-ABT 16 DPB 14 CIM 10 EJK 7 JC 3 EKM 678 DRV 118 DSV 99 ETQ 23 BXM 19 EIP 15 ALD 13 EQS 11 ELJ 10 CHH 6 CTT-DPA-CPU-EYN 5 DGU 2 EOH-CST 1.

## MIDWEST DIVISION

**I**OWA — SCM, Geo. D. Hansen, W9FFD — W9ABE, RM; W9BPG, RM. W9BPG is lined up with W9USA. W9ABE leads. W9DNZ reports W9DPO out of hospital. W9HPA has good total. W9ZZAF paid the SCM a visit. W9ACL says, "phooey and why esk." W9DUN is QRL tennis. W9FYC made a visit to S.C. Club. W9CWG is preparing for fishing. W9BWF reports new freq. meter. W9HUY radios his report. W9FFD returns to the fold. W9IO reports a good time had by all in D.M. W9GXU reports all is well. W9DMX is on the job. W9AYC reports experimenting 80%. W9ERY has trouble with receiver. W9CYL is QRL public address system. W9FXX reports for DTI and ECD. W9JXO reports 56 mc. on the boom. W9LJD reports 9CDJ of "spark days" has become a Benedict. W9BCA is QRL U.S.N.R. W9JI is assisting W9BCA. W9JXA serves her purpose in S. C. W9MOT is new station of the 3rd U.S.N.R. Unit.

Traffic: W9ABE 508 DNZ 319 HPA 230 ZZAF 221 ACL 216 DUN 206 FYC 192 CWG 189 BWF 188 HUY 165 FFD 136 IO 107 GXU 69 DMX 39 AYC 21 ERY 15 GWT 10 AFQ 9 FYX 8 BPG 7 DEA 5 LFF 4 CYL 13.

**K**ANSAS — SCM, O. J. Spetter, W9FLG — W9KG and W9CFN, RMs. W9KG leads the state again. W9CFN says WX too nice for traffic. W9BP expects to rebuild. W9ESL was heard constantly during A.A.R.S. ZAG contest. W9DVQ visits EFE. W9BTG is QRL Standard Oil Co. W9MUY is ORS applicant. W9BYM was heard in ZL. W9KXN is rebuilding to MOPA. W9IQV worked YK. W9FRC put 58 in audio. W9NI (CX7) is installing PP '04As. W9EMH is attending Television school in K. C. WARC is making plans to affiliate with A.R.R.L. W9DWO won PP transmitter. WARC received commendation from RI on help in running down local outlaw station. W9BDB has c.c. 50 watt rig. W9DMF visited the Kansas YL, W9CMV. W9LFB is threatening to put '04A on air. W9ABG talks of changing to c.c. W9CVN has new FB7. W9BEZ and GML plan on getting one. W9GUO has SW3. W9EGL and BSX show activity. W9LMB was transferred to Canadian. Tex. W9MPL is U.S.N.R. NCS. W9HTF has more filter. W9AWP now has c.c. W9DAL has midget 56 mc. receiver. W9BLA is back in Wichita. KVRC issued crystals to all members. W9FLG has orders from doctor to QRT all activity.

Traffic: W9KG 982 ESL 303 BYM 192 ICV 162 FRC 119 KRL 111 AWP 99 GCL 91 FLG 85 KDO 71 LFN 62 COA 38 DVQ 36 PB 30 BTG 26 DMF 16 MUY-IQV 7 BUY-AHR 6 IQI-LGV 5 AWR-GUS 2.

**MISSOURI** — SCM, C. R. Cannady, W9EYG — RMs, W9FTA and W9BMA. ACTIVITY CUP CONTEST won by W9BMA!! The scores of the WINNERS:

W9BMA, 94.6; W9CJR, 94.3; W9FJV 94.3 and W9NP 94. REMEMBER THE SCORING is based on traffic, reports, general activity and promptness in reporting. The cup will be presented at the MIDWEST CONVENTION in St. Louis, September 2-3. W9BMA, FJV, NP and CJR made BPL. W9ASV is also a leader. St. Louis: St. Louis Amateur Radio Club — W9HWE is working 14 mc. 'phone. W9NCB is new ham. W9FTA has new rig. W9DGI and EOW returned to 7 mc. W9FLX was elected secretary when FTA resigned. W9BGE reports as the lone star of the OBP. W9FZJ rebuilt to c.c. W9KIV applies for ORS. W9AAH-KSN reports for first time. W9EFC has new 7 mc. c.c. outfit. W9GTK-ENK is rebuilding whole rig. W9LLN has low power 1.7 mc. rig. W9FAB has SW3. W9KIR and HWF are rebuilding for high power. W9KIK and GSO are building. W9HVN has crystal trouble. W9LFU, EVC, ILL and KSM-CCZ are on 1.7 mc. 'phone. W9LTH having antenna trouble. W9GUQ has new c.c. rig. Kansas City: W9RE sends PB report of U.S.N.R. activities. W9BMA, FHV, JWI, and DPF conclude the K.C. scoring. State News: W9ECE has portable MVO. W9CRM rebuilt receiver. W9HNM reports traffic falling off. W9AHH received extra first ticket. W9GBJ is trying 14 mc. W9DLC keeps the totals up. W9AAN of Richland comes in with nice total. W9ASV says Joplin gang experimenting in 28 mc. work. W9DHN will be back from school soon. W9FYM is still plugging along. W9ALJ has temperature controlled c.c. rig. South Missouri Association of Radio Amateurs — W9HUG is trying to get c.c. job. W9CJR gets in on another chess game with DUM. W9FVM is back from Arkansas U. W9FYU moved. W9LXO got "J" and "VK" on his birthday. W9EYG is back in Monett from Jefferson City and in business with E.H.S. Get in on the new 12-month ACTIVITY CONTEST! Starting with next report!!

Traffic: W9BMA 458 FJV 451 NP 348 ASV 258 CJR 200 HUG 138 EFC 110 GTK 105 AIJ 104 FTA 70 EFC 63 HWE 40 RR-AN 34 DLG 30 FEH 21 LLJ-IXO-FHV 20 FYM 14 GBJ 13 AHH 11 LTH-BGE 8 CFL 10 KIV-EHS 7 FYU-HNM-EYG-CRM 5 FIZ-DPF 4 ENK-JWI-HCP-DUM-AOG-IGP 3 MVO-IJW-BWX-JPT 2 ZZ 1 CXB 16.

NEBRASKA — SCM, S. C. Wallace, W9FAM — W9BNT carries high score. W9DMY is going strong on three bands. W9DFE finally got going. W9EHW keeps FB bunch of schedules. W9DXY says e.c. receiver is FB. W9EWO uses high power. W9DI says school soon over. HURAY. NERTZ. W9DHA joined the Reforestation Army. W9FAM is remodeling whole kaboodle. W9CWM has been helping line up Lincoln Convention. W9MKG plans on attending Natl. Guard Camp. W9DEF is working on 56 mc. stuff. W9HTU hasn't seen any money or beer yet. Hl. W9DHC is working on high-powered rig.

Traffic: W9BNT 814 DMY 163 DFF 160 EHW 80 DXY 67 EWO 10 DI 7 EEW 3 BQR-DGL 2 ISJ 1 CWM 28 DFP 7 HTU 83 DEC 142.

#### NEW ENGLAND DIVISION

CONNECTICUT — SCM, Fred Ells, Jr., W1CTI — W1MK stays in the BPL. W1DOW schedules fifteen stations. W1FV keeps six schedules. W1DGG went to PDC. W1CIG says new operators are coming along well. W1DBU kept 26 schedules a week. W1EFW says there are five new operators in Southington. W1FPM has portable GQK. W1FDM will be on at PBV during summer. W1APW will put a '52 on 14 mc. W1BHM is proud owner of a National "FBX." W1AFB has one schedule. W1DMK and HD have the single signal super bug. W1GC keeps QRM off W1CTI's freq. W1BIQ reported by radio. W1FKT is anxious to handle N.Y.C. and N.J. traffic. W1QV has a '04A. W1CTI popped filter. W1BES blew up power pack. W1UZ says the "water is fine" at Highland Lake. W1BQS is putting W2ESR on air. W1AVB was visited by W1CNU. W1TD made 400 points in ORS party. W1GGX is going full blast. W1AMG has been appointed RM.

Traffic: W1MK 633 DOW 270 AMG 166 FGV 113 CJD 107 AJB 102 DGG 92 CIG 58 DBU 56 EFW 55 FDM 51

ERU 50 APW 42 BHM 41 AFB 38 DMK 36 BYW 34 GC 30 BDI 29 APZ 24 BIQ 23 FKJ 16 QV-CTI 15 BRS 10 UZ 9 EAO 7 FIO 5 FNI-EWD 3 CNU-EAP-GDC 2 AGT 5.

MAINE — SCM, John W. Singleton, W1CDX — The SCM expresses his appreciation on re-election. Winners of Maine Section traffic contest, in order: W1BOF, CRP, EF, CHF, and APX. W1BNC and DKO receive honorable mention. W1BOZ visited the SCM. W1BLI has been DXing. W1VM has new transmitter. W1ASQ is experimenting. W1BUZ is active. W1DTS is back on the air. W1FDT is new ham in South China. W1AQL is on National Guard duty at Ellsworth fire. The Queen City Club put on a play over W1BZ. W1DHH and DRJ are QRL YL. W1FJP is in line for ORS. W1GEU and GPJ are new hams in Auburn. W1BTG is among the leaders. W1EFA is ORS.

Traffic: W1BOF 196 CDX 187 BTG 167 CRP 154 DKO 63 APX 52 EFA 40 DHH 38 EF 27 BLI 23 AGL 21 FJP 15 BYP 19 CHF-AQW 14 DIJ-BTA-AFA-BEU 12 EZR 4 FNG 3 DHE 2 BNC 46.

EASTERN MASSACHUSETTS — SCM, Joseph A. Mullen, W1ASI — For the month of June 16th to July 15th Eastern Mass. is having a traffic contest. All stations in the Section are eligible except the Director, SCM, RM and club stations (more than one opr). Do not send in your message file until asked for. All messages must be handled in standard ARRL form. There will be three prizes: (1) Handbook or Citizens Call Book. (2) Two ARRL Log Books. (3) One pad of message blanks. You do not have to be an ARRL member to take part. All reports on this contest must be postmarked not later than July 16th at midnight. W1BZO leads the traffic men. W1DFS is recuperating after his strenuous session on the Cape Convention. W1BMW reports GOH new president of Cape Cod Radio Club. W1CHR resigned ORS. W1BZY succumbed to an FB-7. W1AGA schedules the Islands. W1ABF is off to sea. W1WV applied for a portable. W1KHX is trying to catch his breath. W1ABG says radio and "biz" are both "rotten." W1ASI is experimenting. W1BPK is big rag-chewer. W1ZC reports for first time from Chelsea Marine hospital. W1CCP expects to be on more often. W1AAX has parts for auction. W1DIU is on 7 mc. W1BRB is building MOPA. W1GAA has his ticket at last. W1BEF handles a lot of traffic. W1BO gave the boys the low down on that lo-loss receiver at Falmouth. W1FZH is a new ham. W1GAG is looking forward to commercial ticket. W1FRO is aspirant for CD appointment. W1EVJ is ORS. W1GF is knocking off DX. W1AJK has new transmitter. W1DMT is on 7 mc. W1BBX moved to Franklin. W1VA is on 56 mc. W1CWA is now using a mike. W1FR has forsaken ham 'phone for photography. W1IA is dabbling with 56 mc. W1DBM is president of the Falmouth Radio Club. The Fast Milton Clan of AKN — CGM — and UG are deeply involved with experiments on the new lo-loss theory for DX. W1FVJ is latest addition to the Quincy QRM generators. W1AKY, BMB and VX are handling the reins of the SSARC. W1CPD gets mad now if the ZLs don't answer his first call. W1CPB is back in the Quincy fold. W1BTD attended the Falmouth Convention with AJA, DNL and BIU. W1BVL finds time to get to hamfests. W1BJA, formerly of the Maine Section, reports here for the first time.

Traffic: W1BZO 153 AGA 100 ASI 83 EJV 68 BBY 61 WV 59 BEF 52 BMW 46 KH 36 ABG 34 CCP 37 FRO 27 CHR 18 UG 20 ZC 11 GAG 9 BFR 5 WU-ALP 4 JL 3 EVE 2 GEC 1.

WESTERN MASSACHUSETTS — SCM, Earl G. Hewinson, W1ASY-W1RB — W1BVR leads the section for first time! Our YL, W1FOF, was second!! W1DVW handled a message from Hallowell to the Portland, Maine newspapers. W1ASY worked K6VG on 3.5 mc. Berkshire County has a new RM, W1EFM, W1APL handled W1ASY rush message to Brattleboro, Vt. W1ECE will use portable BIH in Conn. for the summer. W1AJD has plenty of work. Springfield Radio Assn., W1BWY, is using the equipment won at the convention. W1CJR is working in Army 'phone net. W1BPT reports 100-watt station start-

ing in Holyoke. WIDCH reports DX on 61 mc., W2XK. WIEFQ joined the Zepp fans. WICOF used the convention as a meeting place for W. Mass. gang. W1ADF had better use a mill to write his reports on! W1CWP say 7 mc. not so good. W1BNL is building a SS receiver.

Traffic: W1BVR 95 FOF 73 DVV 63 EFM 53 APL 52 ECE 41 ARE 36 AJD 25 BWY 23 CJR 22 BPT 21 FMJ 15 DCH 13 EFQ-ASY 12 COI-ADF 10 BPN 9 CWP 7 FFJ 5 OF 4 DJQ 3 CJK-CIZ 2 ZB-FNW 1 FCL 6 DLH 34.

NEW HAMPSHIRE—SCM, V. W. Hodge, WIATJ—WIUN continues to lead the Section. W1DSX reports a fine time in AARS contest. W1AXL reports traffic scarce. W1AUU sent in a voluminous report. Outside interests keep W1IP from the key. W1BGL is keeping schedules. W1CEA won a crystal and holder at Kennebunk hamfest. W1AEF was nearly flooded out during heavy rains. W1DNC has '03A going. W1GJE is new ham in Lancaster. W1SK says Bob Monahan of W1FEX gave interesting talk to Rotary Club there. W1DMI is on with c.w. and 'phone. W1BMM has been busy. W1FGM handled quite a few messages. W1BAC has moved for the summer to the White Mts. W1GAJ is new ham at St. Anselm's College, Manchester.

Traffic: W1UN 467 DNC 75 DSX 46 SK 45 DMI 23 BGL 21 FGM 16 AXL 16 EZT-APK 3 EES 4.

RHODE ISLAND—SCM, Stanley W. Atkinson, W1AFO—Thanks, fellows, for electing me SCM for R.I. I would appreciate suggestions for making our Section a real live one. W1EOF reports ORS contests FB. W1ASZ is a member of R.I. 43rd Nat. Guard Sig. Corps. W1CAB relayed traffic from Holland to Mich. W1ESU expects to be transferred to China. W1DAH builds fine condenser mikes. W1EZW is on 1.7 mc. 'phone. W1AXS expects to have a portable in Maine. W1AWE is building new crystal job. W1GIV keeps a number of schedules. W1DDY is active in USNR. W1FNE is an old ham.

Traffic: W1EOF 27 CAB 24 AFO 16 AWE 9 GV-ASZ 8 DDD 7 ESU-AXS 6 EZW 5 DAH 4 DCL-FAH 3 GBK-DBA 2.

VERMONT—SCM, Roy L. Gale, W1BD—W1BD and E1F handled traffic for National Guard. W1BJP uses 1.7 mc. 'phone. W1BNS and BD visited ATF. W1CGV is building 14 mc. portable for the auto. W1GNF is new ham in Windsor. W1CFN has portable FKB; EFC has portable GMY. W1FPS applied for ORS. W1DHX is trying 'phone.

Traffic: W1BD 146 E1F 89 DHX-CGV 59 ATF 45 BJP 35 ERJ 29 AXN 8 DAJ 2.

#### NORTHWESTERN DIVISION

ALASKA—SCM, R. J. Fox, K7PQ—K7KN is on the air again. K7FF messages averaged thirty-six words in length. W7CXH visited PQ on his way to Port Aithorp. K7AOC's fine 'phone will be heard again this summer. K7ANQ went on vacation trip to Sand Point.

Traffic: K7TF 2 ATF 32 VH 53 COF 62 AHK 82 CCL 135 PQ 159 FF 427.

IDAHO—SCM, C. R. Thrapp, W7AYH-CKO—W7BAA leads in traffic. W7AVP handled stack Mother's Day traffic. W7BCU is our only 'phone ham reporting traffic. W7JY reports by radio. W7CHN is rebuilding c.c. rig. W7CAP and CHN dropped in on the SCM. W7DD is experimenting. W7CMD passed his commercial exam. W7BAR says 3.9 mc. 'phone getting tough from QRN. W7CZO has new FB7.

Traffic: W7BAA 99 AVP 65 JY 53 DD-BCU 4.

MONTANA—SCM, O. W. Viers, W7AAT-7QT—W7ASQ moved to new QRA. W7AQN has nice total. W7CCR is going in for 'phone. W7GBC is busy at college. W7AOD reports for CHW and BXX. W7BDJ has trouble with c.c. rig. W7BYR is on again. W7CRH and W7HP are the star traffic stations. W7BOZ worked K6GQF. W7CRD has portable DBV. W7BSU moved to Conrad. W7BUJ is rebuilding. W7AHN and BMX are building c.c. rigs. W7BYE works DX. W7AAT finds weather conditions improving.

Traffic: W7CRH 240 HP 244 BOZ 35 CTP 5 BXK 46 FL 8 ASQ 19 AQN 128 CCR 52 AOD 6 BYR 27 BMX 90.

OREGON—SCM, Raymond W. Cummins, W7ABZ-CBB—W7KL is new Route Manager. W7SO resigned. W7DAK, AHK, and BMR prove that Gresham is DX locality. W7BGF is going c.c. W7ASG, LY, CNV, CQO, APF, BHT, and BTH visited SCM. W7ABD reports via air mail. Benson Polytechnic School, Portland, had W7SB on the air during Tech Show. An old timer returns, W7GG. W7AHL, AOI, AYW are new ORS. W7CXX is traffic minded. W7DCI, DEA, DBR, and DEE are new CBARC hams. W7BUF is going 1.7 mc. 'phone. W7MY and AVB have been working FB DX. W7SY had a vacation in Mexico. 1.7 mc. 'phone net is being formed by W7AHZ with AEM, and CFM. All interested in this net, get in touch immediately with AHZ. W7UJ has e.c. on 3.5 mc. W7QW is on 'phone again. W7BDU went to work. W7BEK sticks to 56 mc. W7BRH is A.A.R.S. W7AQX wonders why his 1000 watt 'phone QRMs BCL. W7AIG and DP made good scores in ZAG contest. W7AIP gets on the air. W7BO got unlimited 'phone ticket. W7BEE has FB7. W7AYN is using portable BRQ. W7BUT, and ZZAR are in new locations. W7BDG, and SK were hosts to a hamfest in Waldport. W7WR wins ORS prize for most effort in helping SCM. W7AYV shared honors. W7DDZ made 14 deliveries on first day of operating. W7CRN has portable. W7MF has e.c. freq. meter. W7WL is QRL postoffice scheme exams. The Rose City Amateur Radio Club announces plans complete for the biggest and best convention ever held. Dates Aug. 18 and 19th, 1933.

Traffic: W7AWH 619 KL 653 LT 334 MF 305 AXJ 297 ABD 245 DP 223 WR 214 AHJ 200 SY 198 PL 176 CEJ 155 BLJ 187 AYW 130 APE 120 AJX 98 HD-SB 95 ABZ 87 CFM 84 AEM 82 AIG 65 AMF 52 CXK 48 BLN 46 ZZZ 40 WL 37 DDD 24 COU 21 BOO-AYB 14 AHK 11 AID-APF 10 BBO 9 AXO 8 AOI 7 BWD 6 BMR-ALM 5 BKL-LI 2 BOH-AZJ-BMA 1.

WASHINGTON—SCM, John P. Gruble, W7RT—Due to outside business, I regret that I must resign my office of SCM for this Section. Thanks to you, gang, for your splendid support in the past. W7AYO, of Yakima, is acting SCM, to whom all reports should be sent until the election of a regular SCM in the near future. Address all correspondence to: Stanley Belliveau, W7AYO, Route 7, Box 387, Yakima, Wash. W7BBY is visiting L.A. W7IG is to be congratulated on making BPL. FB, OM! Through the efforts of Wallace, W7MM-ZZT, Bremerton recently added 28 newly licensed hams to its list! Please get behind W7AYO and we'll put Washington up on top . . . will be seen' ya' gang, and 73. Hasta la vista!

Traffic: W7IG 575 BSX 398 WY 252 BWS 222 BHH 206 OO 39 AHQ 30 CWN 2 CPD 8 BCC 112 AZA 39 BYS 17 TZ 2 AFC 36 CHH 9 BRE 121 BCE 82 CGI-ABU 2 HS 12 CSA 7 BRG 10 CYO 1 CAM 54 US 12 AVM 2 BNI 163 BHG 8 AAF 13 APS 43 AIT 78 CZB 93 BDW 1 BQX 4 CSK 19 CSO 3 BMU 5 CHZ 35 RL 18 AQ 21 AUP-BYB 7 BCS 6 AYC 4 AAL-DCN 1 CXC 7 AGV 4 LD 31 BGH 103 APR-CXL 9 CNS 4 CZY 34 BAC 8 CND 26 CTS 4 CYW 6 ALE 4 CQI 121 BVO 22 BIW 40 KO 7 CHU-CLR-CRR 2 BFG 30 CDC 20 AHT 8 BRG 3 BB 126 AZC 2 IC 3 CNB 22. W6CZL 28.

#### PACIFIC DIVISION

HAWAII—SCM, C. D. Slaten, K6COG—K6EWQ has a follower into BPL this month, K6GUA! K6FAZ and CRW, combining the pleasures of mountain climbing, goat hunting and hamming went on a jaunt up Haleakala with an '01A portable using call K6DSK. K6HOO returned from a trip by Navy plane to Frigate Shoals. K6EEI and AIU are back on the air. K6AJA has ordered Collins transmitter and an FB 7. K6EBR has TPTG '04A. K6DQF is working his lone '10. K6GQF will soon have c.c. K6AGI is on with pair of '03A's. K6DWW is on 1.7 mc. 'phone. K6DBE is rebuilding. K6BAZ is trying to make his doubler double.

Traffic: K6EWQ 1047 GUA 723 FAB 271 GQF 69 CRT 48 HOO 22 GZI 19 CIB 15 ACW 13 COG 7.

NEVADA—SCM, Keston L. Ramsey, W6EAD—W6AJP is working USNR drills. W6UO has three



schedules daily. W6FUO is going in for 'phone. W6BTJ rebuilt. W6EAD is rebuilding.

Traffic: W6AJP 211 UO 112.

LOS ANGELES—SCM, Francis C. Martin, W6AAN—Eight stations make BPL. Our reporters with no traffic totals: W6DOK, DWV, EII, EME, ERL, FSE, GNM, GOX, GPX, LC, ON and SN. W6EUV is QRL final exams. W6DLN is running remote for KFAC. W6DWP blew up his rig calling ZLAA. Our YL of the BPL, W6EK is taking Beauty College course. Mills of W6AEO took commercial exam. Reports indicate W6BDZ has signed up an assistant op for life. W6MK is back in a big way. W6EII went hamming back to Iowa. W6CVF joins the Army net. Pair of tens brings good DX to W6GSH. W6DJC recently operated on USGS ship PIONEER. W5TH spent some time with W6CXW. Give W6AZU some of your K6 traffic; he has daily schedules. W6BPU has worked schedules every day for over six months with W6PQ! W6LC reports summer vacation for code class of YLs. W6FGQ is putting 350 watts on '52. Santa Barbara Amateur Radio Club is rebuilding for c.c. Daily schedules at W6ETL with KAIHR, OMITB and K6EWQ. W6IGU is new "ham" in Burbank district. W6CCF has new rig. The Army Net takes over communication for the Reforestation Camps and from the Section we have already had assignment of W6CQM, ETM and AUB, with ETJ standing by for orders. New shack at W6AUF. If you attend San Gabriel Valley Club meeting take plenty of gasoline—ask W6FEW and AAN. Hi.

Traffic: W6ETL 1258 EDW 723 BPU 562 EBK 522 AZU 416 BSV 355 CQM 309 ETJ 254 FGT 243 AKW 236 NF 232 BZF 142 CVF 131 BZI 128 DNA 125 FFN 113 EGJ 110 DQZ 102 EZG 101 DBC-GMA 96 GXM 84 DWP 81 DYJ 72 AAN 71 AIF 57 DJS 55 DRQ-EAR 69 ZZBK 66 FNG 61 AFU 40 AM 51 CZT 41 FVD 51 GLZ 50 HT 56 MK 44 YBB 39 BGN 23 CUY 27 CVV 26 EUV 22 FKF 27 FWN 26 GFG 19 BFL 19 HEW 15 HOG 14 LY 19 PB 15 ACL 16 ADH 18 BCE 18 CCF 16 CIX 15 CYS 14 DJC 13 DOP-FEW 12 EGS 14 TE 10 DVT-EK 9 AEO-DTX-DYQ-HXU 8 CGP 7 CXW-DEH-EDZ-ETX-FET-FXL 6 BHP-BVZ-DBJ-DLN-FZL 5 BRO-CDM-ESK-EWC-FDM-FGQ-FXF-FZC 4 CTZ-DOZ-DZI-EMY-FLY-FMP-ZZA 3 AGF-BER-BPD-CLY-DVV-GEX-MA-EXQ 2 BGF-FJS-GNZ-GSH-GTE 1.

SANTA CLARA VALLEY—SCM, Bruce Stone, W6AMM—W6FBW is speedily recovering from his operation. W6HM and GEO are faithfully holding up their end of good TP schedules. W6FQY reported from KG. W6CNN keeps schedule with Washington. W6YL is having wonderful results on 1.7 mc. 'phone. W6AOD is becoming real active. W6DJP is experimenting with AAZ on 56 mc. W6CNI ran half a mile at 10:30 PM, saved a party an unnecessary trip to Santa Cruz, and was highly complimented by said party. W6NX is being crystal-controlled and will then be the most powerful outfit in this USNR district. W6QR is trying traffic work on 1.7 mc. 'phone. W6BRW is forced to temporarily withdraw from the game. W6DDS says the Watsonville fire-chief is ready for his exam. W6GGM says a long receiving antenna is as good as an extra stage of AF.

Traffic: W6HM 387 YG 135 DBB 102 CEO 100 KG 64 CNN 49 NJ 37 YL 27 AOD 24 DJP 21 CNI 19 NX 18 QR 17 AZC 13 FMT 11 YX-DEH 7 GOZ-DSE 5 CDX 3 HZW 1.

EAST BAY—SCM, S. C. Houston, W6ZM—CRM J. H. MacLafferty, Jr., W6RJ. RM J. Claussen, W6AUT. Three stations make the BPL. W6TII turned in the biggest total. W6CDA has found a way to finance his power bill. W6HHM won the traffic trophy for the six months ending April 15th. W6RJ is keeping regular schedules. W6FAC handles quite a bit of traffic concerning the Civilian Conservation Corps. W6RF has been active with the Naval Reserve. The Radio Class of Central Trades School, W6YM, visited KEL. W6IT broke his previous record of messages handled. W6HRN has been working a few J's. W6CIZ has been plugging along. W6AF has been QRL with railroad work. W6ZM has been pound-

ing brass at AQ. W6ANS-AHI put up new antenna. W6DHS changed QRA. W6FII sends an FB report. W6CZN is complaining about the weather. W6BYS is rebuilding. W6APT joined the AARS. W6GYA is teaching code to a beginner. At the Tri-Section Hamfest held in Oakland May 20th, our flying Director, S. G. Culver, reported on the Directors' Meeting. This was one of the best gatherings held hereabouts for quite a time; about 150 hams were present. The East Bay Section cordially invites all amateurs to attend the Section meetings, held the second and fourth Fridays at Central Trades School, Oakland.

Traffic: W6TI 870 CDA 773 HHM 599 RJ 355 FAC 208 RF 116 YM 35 IT 21 HRN 18 CIZ 15 AF-AQ 13 ANS-DHS 12 EKB 11 EJA 10 IY 6 DKJ 3 CBF 6 AUT 4 FII 322.

SAN FRANCISCO—SCM, Byron Goodman, W6CAL,—C'mon gang, let's show 'em we can do it! Please report! W6PQ and NK, the old reliables, BPL as usual. W6EKC returns to the fold with a swell total. TL W6CIS vacations in Yosemite with a '10 portable. YL station W6ATP sends in a nice report. W6HSQ at Healdsburg plans 56 mc. expedition with BTZ, AEK, and CSX to Mt. St. Helena. RM W6BVL is going after a commercial ticket. W6MV schedules W9USA. W6AZX has nice signal on 28 mc. W6BIP was heard in Latvia on 7 mc. Let's have those reports gang, so you can get "HAM FLASHES," which runs six pages now.

Traffic: W6PT 1580 EKC 249 NK 177 CIS 125 BVL 77 ATP 46 GIS 31 EKQ 15 GPB 14 BIM 12 MV-CAL 8 DXW 9 HIR 7 GKO-AZX-AVY 5 DZZ-GWW-FWK 3 COP-BIP-ENM 2 ABB-DTR 1 IU 9.

SACRAMENTO VALLEY—SCM, Geo. L. Woodington, W6DVE—W6GVM has new 50 wattler. W6DGJ is a new call. W6FLR is on 1.7 mc. 'phone. W6GSS is buying new rig. W6GCM is on 3.5 mc. W6GUK is getting along. W6AIM is back on the job. W6NT worked a K7 and a ZL2 on 3.5 mc. W6GAC wants schedule with Los Angeles. W6GTZ, GSD, and FPH visited the SCM. W6EFM has completed MOPA job and has it in a Glass case. W6CIR sent in a substitute for an RF meter. W6GUV is pursuing studies at the Chico teachers college. W6BHM is preparing to find that naval signal somewhere in the west. W6HKM blew his filter. W6CRN and CUM are going to 56 mc. W6HAS received a heard card from Australia. W6HHE had his appendix out. W6HKM and HMB are new calls. W6SK is right on the job. W6AHN attended Oakland Hamfest. W6HEP is ex-BBR. W6HYF did some very fine work in getting the Assembly Bill amended to exempt amateur operators.

Traffic: W6CKO 641 DVD 287 CGJ 165 GAC 105 AK 103 GKX 44 AIM 33 EWB 42 FPH 24 AHN 18 FW 16 HYF 15 DVE 14 BYB 10 HLQ 9 GZY 1.

ARIZONA—SCM, Ernest Mendoza, W6BJF-QC—W6EFC is high traffic man. W6ALU makes BPL on deliveries. W6FZQ is newly appointed ORS. W6CEC-W6BCC, and his OW, W6BWN, have moved to Riverside, California. Ex-NU6BZO now signs IEY. Ex-U6AAM is IMR. W6AEK has portable IKN. W6IIF and IIG (12 yrs.) are brothers. W6DOW keeps daily schedules from Boy Scout camp in northern Arizona to QC with portable IJQ. W6CLL has portable IPT. W6DFE's portable is GGV. W6HBQ has a portable ILE. New calls include: W6IGC, IID, HUZ, IPH, IGI, IKX. W6BLP was heard in ZL on 3.5 mc. W6BGN enjoys A.A.R.S. W6DRE is doing fine work on 14 mc. W6BRI is cashier at Sears Roebuck Co. W6GZU plans new rig. W6CQF reports for Tucson hams. W6HBF is using c.c. W6FWI uses a c.c. 50 wattler. W6EGI worked VE4EA on 14 mc. 'phone. W6FIP is in Oregon on furlough. W6FDW is using FIP's crystal. W6FLG is at new QRA, Killbuck, Ohio. W6GFS is at new QRA in Tucson. W6CVW has been on 14 mc. W6CLL rebuilt. W6UG took the fatal step! W6FKX works on 3.5 mc. W6DPS holds a fifth district portable, W6CUS. W6ZZBC was in Phoenix for a few days. W6BYD boasts an e.c. frequency meter. W6DSQ has an e.c. osc. W6FOH looked up BYD and EKU while in Phoenix. W6DDZ thought he had sold his '04A to EL at Prescott!

Traffic: W6EFC 734 ALU 717 BLP 215 GBN 105 QC 84 DRE 24 BRI 14 GZU 11 CEC 8 CQF-HBF 7 BJJ 4 GFK-GDI 3.

PHILIPPINES — Acting SCM, Newton E. Thompson, KAIKA — P.I. amateurs held monthly meeting at KAIHR May 28.

Traffic: KAIHR 1016 LG 534 CO 219 NA 103 BA 77 PS 39 NF 44 TS 25 JR 23. KA4HW 30. OM1TB 507.

SAN DIEGO — SCM, H. A. Ambler, W6EOP — W6BMC still leads the Section. W6BGL turns in a fine report. W6DQN has five schedules. W6AXN has schedule with Omaha. W6EFK had as a caller W6NW. W6FWJ was away most all month. W6DYU is handling schedules for FQU, W6EWU, GOG, IBK and FQD are on 1.7 mc. 'phone. W6BLZ reports a new ham in Laguna. W6GVU is now in Oceanside. W6FP, EWO and GVV called on the SCM. W6AXN was in A.A.R.S. contest. W6CNQ cancelled schedules for the summer. W6LD reports via 1.7 mc. 'phone. W6BAM is building new receiver. W6DNS is building transmitting sets for fishing boats. Ex-W6CZK is back in town. W6APG has FB 7 receiver. W6FGU is remote control.

Traffic: W6BMC 935 BGL 123 DQN-AXN 118 EFK 93 FWJ 57 DYU 20 EWU 15 BLZ 6 IBK 4 AKY-CTP 3 BCF-BHV 2.

SAN JOAQUIN VALLEY — SCM, G. H. Lavender, W6DZN — W6CUL is radio op on a pleasure cruise in the South Sea Islands. W6AV is QRL U.S.N.R. W6FAG is heard on 3.9 mc. 'phone. W6EXH turns in best traffic report. W6GJO is increasing power. W6CVA is on regularly. W6BXB turned to 'phone. W6BFH is Alt Unit Control in U.S.N.R. W6YB has high powered rig on 14, 7 and 3.5 mc. W6FFU has c.c. on the way. W6AME has crystals for almost any part of the band. W6BIL reports for Tulare gang. W6GZE moved to S.F. W6EUQ is a traffic hound. W6ASV is DXer. W6BTN has FB 14 mc. 'phone. W6BIL has a job! W6BNH and AOZ have new transmitters. W6GEG is rebuilding. W6ENA is active A.A.R.S. W6CVT has new c.c. job. W6DQV is back on the air. W6FFP is QRL family. W6CVL is N.C.S. in A.A.R.S. W6BRU is dispatcher for Santa Fe RR in Stockton. W6DZN is planning on going to mountains for the summer. W6BRV handled 500 messages last month and forgot to report.

Traffic: W6EXH 317 GEG 115 FFU 104 ENA 75 AME 64 DZN 63 EUQ 120 CVT 36 GJO 33 CVA 31 YB 28 DJJ 7 GHS 10 PZA-FRH 6 GFR 4.

#### ROANOKE DIVISION

NORTH CAROLINA — SCM, G. H. Wright, Jr., W4AVT — Thanks for the fine bunch of reports, gang. FB! W4HX, HI, AWZ, TH, AL, and TO are getting their 56-mc. rigs ready. W4IF is on 14 mc. W4BJZ and OG have added '52 in final. W4ABT is QRL YL. W4NC was QRL RDC contest. W4AWU is studying E.E. at Weaver College. W4PGL is new ham in Winston-Salem. W4BHR gets ORS. W4JR gets his renewed. W4RE is doing FB U.S.N.R. work. W4AIS wants a copy of "The Tar Heel Ham." W4TP sends a nice traffic report. W4ALT is rearing to QSP. W4AAE has all-U.S. portable call W4PCR. W4BJV formerly worked calls 4AB-4SU-4CM. W4QI and ANU have 3.9 mc. 'phones ready. W4ATC is State College Radio Club station. The Central Carolina Radio Club meetings are well attended. W4DW is QRL home duties. W4AA and ATS are getting ready for OO work. Vice-president Stewart, of A.R.R.L., was a visitor in the section. W4VN is rebuilding. W4TO had a serious auto accident May 12th. W4BUE and BVY have low power 1.7 mc. 'phones. W4ANU's Hi-voltage transformer went west. W4JB has about completed Single Signal receiver. W4CP has Automatic CQ machine. W4BV passed exam. Winston-Salem leads the Section in activity.

Traffic: W4AIS 356 ZH 254 NC 158 EG 123 ANU 74 TP 65 JB 55 BJV 52 BHR 44 VN 43 CBX 42 AOE 30 OG 24 AVT 23 PFA 22 AWU 21 DW 14 RE-AIT 12 BPU-ATC-TJ 11 AOA-AAE-QI 9 TO-IF 8 MR-BRK 5 AHY 4 TR-BUE-BRT 3 DQ-BV-PGL 2 OC-BYA-CAY-ABT-BIU 1 AGH/PDC 11.

VIRGINIA — SCM, R. N. Eubank, W4AAJ — New calls: W3AAR, DDF, CKY, CIA-, DBI, DKJ, DME, DES, CYK, DII, DHO, CTC, DKD, DFU. Have new FB 7: W3BIG, AEW, BDZ, AAJ, ASK. Added equipment: W3CSI, AHW, AKN, ASK, CKM, BYA, WW, CGR, CFL. Working DX: W3BFQ, AG, BLE, AZU, NE, DAM, QYU, CHE. Rebuilding: W3GY, NO, BZE, BNH, AGW, QN, DEH. New traffic reporters: W3BYQ, CFV, AJA, AEW, AGY, BAN, CLV, DES, CYK, CVQ, COJ, DCU, BDQ, AHC, CGR, DEH, DKD, DFJ, AVL, BZ, CAH. Changed r.a.c. to d.c.: W3GE. QRL: W3BEP, AAF, AVR, MQ. After A.A.R.S.: W3BLE, and BAD. After better license: W3AGY and DCK. New rigs: W3CLV, AHW, AUG, CVN. After ORS: W3CDW, DFW. Inactive but report: W3ATY, IQ, MT, BLE, UVA, CAX, BEV, CTC, BAG. Want schedules: W3BFW, BGS, CFV, CFL. Experimenting: W3CZX, DEH, TN. On 'phone and c.w.: W3BAI. New antenna: W3BPI. New QRA: W3CYM. W3DDE passed away May 14th. W3WO is opr. on U. S. Gilbert, Norfolk. W3BSM is with Eastern Air Transport. W3DBI is call of Petersburg Club. W3CVU wants '52 or '60. W3BJX lost his father. W3CXM makes BPL. W3BAN is still our best Official Observer. W3AKN is after 7000 kc. com'ls. W3NT is new NCS, A.A.R.S. W3CMJ is in Va. net. W3CNY, BTM and CVN are OBS. W3BRY is FB RM. W3EF uses FB portable. W3BRA sends much dope. W3BUR is back in Roanoke. W3DCU makes FB total. W3BXP will be in Forestry group 6 months. W3BIW has portable DKD. W3AHC sends dope on Staunton. W3CJH is working on club. W3TN will receive cards monthly. W3AVL was hurt in auto accident. W3CAH is back from Akron.

Traffic: W3GE 51 CFV 33 BSM 6 AG 4 CVU 3 AOT 1 AZU-AGY-AJA 2 BAN 5 CLV 3 NE-BZE-CYU 2 NT 772 FJ 101 AVR 1 BGS 14 BRY 13 BSB 3 BXP 97 BYA 34 CVN 122 CVQ 7 DCU 40 AAJ 145 GY 10 CSI 6 BIG 3 BYQ 2 AEW 6 AAF 38 AKN 6 BJB 21 CXM 502 CDW 10 BNH 37 AUG 15 CMJ 71 CNY 2 BFW 11 CZX 17 BAI 29 DES 11 ASK 1 BPI 23 CKM 4 CYK 7 COJ 3 BDQ 1 CFL 11 DEH 2 QN 31 CGR 1 CHE 15 BIW 61 DFU 2 DKD 1 AHC 17 CLH 32 CFV 25 TN 15 DDE 7 AHQ 23 AEI 12 AII-OM 2 BTM 4 COO 11 BZ-CAH 1 BRA-DDG 2. AVL 2. BPA 10 WM 2 APT 11 DFW 10 WPF 2. W2A 2 BRE-EJ 2.

WEST VIRGINIA — SCM, C. S. Hoffmann, Jr., W8HD — W8HD has W9USA schedule. W8EIK and GB will possibly be alternates. W8CMJ won the crystal offered by W8GB for handling the most traffic! W8CDV and ELO graduated from electrical engineering dept. of Linsly Institute at Wheeling. W8BHG, FQB and ETX are building c.c. rigs. W8DWZ is house-cleaning. W8HWT boasts a new MOPA. W8HCL is using c.c. W8GRJ worked VK6FO. W8BKG has sky hook trouble. W8CSF left for reforestation camp in Tennessee. W8HSA has portable JAM. W8FQB has portable JCX. W8DSJ has portable JEH. New stations reported: W8JBT, JBY, JLZ, JHU. W8ELJ took a gang to Bluefield. W8TI is experimenting with high speed motors. Do not forget the high score station for the next several months gets a crystal, calibrated to his own frequency, from W8GB. The SCM appreciates all the compliments and promises of cooperation on the W. Va. Bulletin.

Traffic: W8CMJ 196 ELK 87 BHG 78 OK/WLHA 72 ELJ 55 CSF 52 HD/WLHB 49 BOW 42 HCL 28 BWK 22 ELO 15 TI 16 DPO-FQB 12 HSA 14 BKG 9 CDE/-ZZU 7 EWM 1.

#### ROCKY MOUNTAIN DIVISION

COLORADO — SCM, T. R. Becker, W9BTO — Congratulations to the Rocky Ford gang on the fine ham-fest of May 13th. Colo. Springs is making a strong bid for the State Convention. Boulder hams were host to a number of fellows on Engineers Day, May 23rd. The U.S.N.R., headed by Mr. Slusser of KOA, is doing some fine work. W9BCW, EYN, FYG, GLI, GNK, JFD, JB, CWA, and EBW are all active Colo. U.S.N.R. stations. W9ESA takes the lead in traffic. W9CDE and HFW are pounding out A.A.R.S. traffic. W9JNV is running a school

for beginners. W9GNK is control station for Colo. U.S.N.R. The kid brother is the latest addition to the brass pounding family of W9GLL. W9EYN will be on 56 and 28 mc. from the top of Pikes Peak, June 10-11. W9EHV is convalescing. W8FIO is now signing W9MJM. W9JCQ is on from new QRA. W9EXV is back from west coast. W9DNP dropped the ham bug for several real "bugs" at KVOR. W9EPN will soon add to the QRM. W9IQS is running 160 watts into a pair of '45s. W9JAV moved to the mountains. W9MKG reports from Holdredge, Nebraska. W9LLB, CKO, BYC, and YL are on from Boulder. W9CKO will soon have a new rig. W9LUO, LYV, MEP, and MVI are new Colo. hams. W9GLG is QRL job. W9KKY, LNB, and IFD are on 1.7 mc. 'phone. W9CLX is rebuilding. W9HKO is on with new outfit. W9JGF passed unlimited 'phone. W9ACV reports traffic. W9BTO is running 700 watts into a pair of '52s. W9LJM is building a super. W9FYG is on from Alma signing GVN. W9CJJ is QRL KFEL. W9IJU dropping radio in favor of prospecting. W9FYY will burn the gang up with that bug of his. W9HRI, BYK, CBU, HDI and BTO are proud owners of new receivers. W9LPH says the s.s. super is FB. W9BYV is trying a 50 watter in his P.A. W9AUJ is QRL beer. W9JB has a new QRA with 14 rooms. W9JNV and EYN are planning new c.c. club transmitter. The Springs portable emergency transmitter is working FB, and will be on during the tests June 10-11. W9LFE lost his fifty watter.

Traffic: W9BTO 16 HFV 4 JB 12 ACV 25 JGF 9 MJM 34 EYN 536 LQO 3 GLI 19 GNK 159 JNV 55 CDE 39 ESA 872 JQV 7 LFE 6 LQS 1 IFD 2.

UTAH-WYOMING, SCM, C. R. Miller, W6DPJ-W6ZZZ—RM W6EXL. Watch for W7COH's official broadcasts on 3633 kc. 6:30 p.m. Tues., Thurs., and Sat. W6DPJ and APM made BFL. W7AMU enjoyed A.A.R.S. contest. W7CHR has been building a portable. W7ACQ works DX. W7BTE will move to Cheyenne. W6GQC reported by radio. W6EXL is organizing a state traffic net! W6FRN has two new masts. W6GPJ is printing QSL cards. W6DGR offered a National FB-X.

Traffic: W6DPJ 617 APM 163 DPO 131 EXL 94 GQC 71 AFN 51 HHI 7 FRN 11 HWI-DGR 5. W7AMU 103 COH 72 COV 7.

#### SOUTHEASTERN DIVISION

ALABAMA—SCM, L. D. Elwell, W4KP-W4AAQ, DS and APU are high traffic stations. The first op at W4AAQ carried a portable into the storm stricken area, at Helena. W4BSL contacted AAQ the morning of the storm and gave news for the WAPI. W4DD has gone to north Alabama. W4BAI is busy graduating. W4BRX is a new reporter. W4ZS is QRL. W4DS is handling traffic routes FB. W4ACQ will try for 'phone soon. W4APY has joined c.c. gang. W4AYK is QRL BCLs. W4FL made a good showing in ZAG contest. W4BPY expects to ham again. W4BOU sends FB report. W4BZG is a doctor. W4AUP is on the active list. W4BJA and AG says the bulletin FB. W4BSQ is working for the Birmingham Club members.

Traffic: W4AAQ 115 DS 113 APU 100 BAI 86 FL 53 AJC 29 HOU-AJY 15 AYK 12 ZS 11 BJA 7 BPY 1.

EASTERN FLORIDA—SCM, Ray Atkinson, W4NN—W4BGG made the 100 total club. New 'phones: W4ANY, AGB, AJX, ALP, NF and AWE. W4NN is on 14-mc. 'phone W4ACZ and DU increased power. W4WS reports traffic. W4ALP, AGB, ANY, and AJX have unlimited 'phone tickets. W4BOT is building 14 mc. rig. W4AKJ is working new portable. W4PQ is DXing on 14 mc. W4TZ is now WAC. W4WZ applied for new license. W4AFV is working Army net. W4AII pounds brass at WPD. W4AZF is building crystal rig. W4BNR has new 1.7-mc. 'phone. W4PT is building a portable. W4VP is down with a bad back. W4BGL joined A.A.R.S. W4WS and BAM send traffic reports. A new station at Miami is W4BYF. W4BIN is going to C.M.T.C. The Florida Nat. Guard emergency net includes the following: W4GS, BHL, SC, PFO, BQ, ANJ, DY, IR, ASE and NF-IP. W4BHW is president of Seminole Radio Club.

Traffic: W4BGG 107 NN 74 AKJ 72 WS 36 ALP 30

BAM 22 AGB 17 VP-AJX 9 AII 6 BGL 5 BNR 3 BHW 42.

WESTERN FLORIDA—SCM, Eddie Collins, W4MS-W4ZZP. RM: W4ACB-PCN. W4ZZAO, ABK and ASV-ZZW have new operator's licenses. W4QK is starting an a.c. receiver. W4BPI is dreaming of c.c. W4BGA has 60 foot tower. W4KB installed a double button mike. W4BSJ received cards from Africa and Europe. W4BFD passed fone exam. W4QR-PEL is moving. W4UAU handles U.S.N.R. traffic. W4BKV is active in Tally. W4AXP moved to 7 mc. W4AQA is building BCL sets. W4AQY and VR are QRL YLs. W4QG and MM were visitors. W4QU is rebuilding. W6HET has trouble with 'O3As. W5ZZR is about ready to go on aircraft carrier. W1GPK is in our midst. W9FFD, SCM Iowa, paid Tally fellows a visit. W4BGB, AGS, BPI and ARV graduated from HI School. W4AUW is running tests on 28 mc. W4BOW has an a.c. receiver. W4BKD promises a big summer. W4BMJ wants a W7. W4AUV gave up 1.7-mc. 'phone. Ex-W4ADV has an op license. W4CDE is a new station. W4MS-ZZP is building MOPA.

Traffic: W4KB 55 MS 12 AXF 1 BSJ 11 ACB 4 AGS 2 BFD 1 ZZAO 3 AQY 2 BPI 1 ARV-AUW 3.

GEORGIA-SOUTH CAROLINA-CUBA-ISLE OF PINES-PORTO RICO-VIRGIN ISLANDS—SCM, Chas. W. Davis, W4PM—W4WZ is rebuilding W7OC. W4ATZ and BQX are new ORS. Send ATZ self addressed Lyman, S. C. W4BXN and BRG want traffic and schedules. W4PM's new portable is W4CBQ. The SCM's QRA will be 91 North Ave., N. W., Atlanta until further notice.

Traffic: W4LR 199 AAY 22 BWN 50 SS 6 BW 9 BQX 15 BRG 27 MA 81 VX 3 BDT 4 ATZ 20.

#### WEST GULF DIVISION

NORTHERN TEXAS—SCM, Glen E. Talbutt, N5AUL—Howdy, gang, I'm glad to be your new SCM. All reporting stations will receive a monthly traffic bulletin. W5BII leads the traffic totals. W5BCW is an 00. W5CJW wants ORS. W5ARS has seven schedules. W5AJG can't keep the totals down. W5ANU has spring fever. W5IT was acting SNCS for A.A.R.S., while W5BBQ was off. W5CAV is big traffic man from Waco. W5BFI has FB-7. W5ARV graduated from College. W5CPT and CPB have consolidated. W5CHJ has new "phone" ticket. W5RH is rebuilding. W5AVF is commercial "op" on the Mississippi. W5BEQ started work on c.c. rig. W5BEO is QRL school. W5AIZ "washed up" the family Buick. The Cen-Tex Club met at W5DDP's. W5LM is selling out. W5CKP operates on 14 mc. W5AMK report conditions bad on 7 mc. More than 55 hams joined in the annual banquet of the Wichita Falls Amateur Radio Club, marking installation of W. W. Robertson as president. A "big" time was enjoyed. The WFARC is making a bid for the 1934 W. G. Convention.

Traffic: W5BII 302 CIJ 213 BCW 103 ARS 100 AUL 96 AHC 85 AJG 73 ANU 72 IT 48 CAV 39 ASA 34 BFI 26 BNF 18 JA 17 ARV 4.

OKLAHOMA—SCM, Emil Gisel, W5VQ—W5BMU is high man. W5CEZ made the BPL. W5AKX lost some schedules. W5BDX and ASF are big traffic men. W5AND has portable DDU. W5AVK is QRL school. W5TC is coming on with high power. W5BVR has a case of YLitis. W5CVA reports conditions poor on 7 mc. W5CJZ has two crystals perking. W5BMT is coming on 14 mc. c.w. and 1.7-mc. 'phone. W5PP-AJO is going to 14-mc. 'phone. W5DDM is perking on 7 and 3.5 c.w. W5DGS is new man in Fort Sill. W5BHQ and BPM are rebuilding.

Traffic: W5BMU 586 CEZ 547 ASF 321 BDX 216 AKX 43 BPM 42 BOE 36 CVA 16 BQA 12 CJZ 9 AND 8 VQ 113.

SOUTHERN TEXAS—SCM, D. H. Calk, W5BHO—W5OW leads in traffic. W5YL is rebuilding. W5BKE is Chief Route Manager. W5MN keeps six good schedules. W5AFQ-CJJ reports for first time in this Section. W5ABH reports for gang in Rio Grande Valley. W5CQE works DX. W5BSP works DX from ABH. W5CNX returns home from school. W5BKI, RV, EU, and BUV have completed 56 mc. rig. W5BKI and JC are building 14-mc. 'phone. W5BKY-UW wants more schedules. W5BDN is

new ham. W5ADZ worked KN2. W5YH worked VE3's. W5PF reports W9ZZAD on the air in the Alamo City. W5ON is building 3.9-mc. meter 'phones for the fellows in Houston. W5OX is QRL KGZB.

Traffic: W5OW 1015 BKE 167 AFQ 84 MN 48 YL 47 YH 17 PF 10 BUV 5 BKY 6 ADZ 3 DBN-ABH 2.

NEW MEXICO — SCM, Jerry Quinn, Jr., W5AUW — W5BNT is our prize traffic man. W5CWM is leaving us to be a W9. W5BVC reports new ham in Clovis, W5CXP. W5MP is back from R.C.A. W5CGJ is bothered by local power co. W5AOP got a new fifty wattter. W5JZ wants a schedule with Las Vegas. W5AUW is hunting up '52s. All correspondence to the SCM should be addressed to Jerry Quinn, Jr., 524 West Coal Ave., Albuquerque, N. M.

Traffic: W5BNT 8S AUW 81 CWM 70 ZM 44 ZZQ 23 BVC 18 CGJ-AOP 10 JZ-AAAX 8 CVG 6.

## CANADA

### MARITIME DIVISION

NOVA SCOTIA — SCM, A. M. Crowell, VE1DQ — VEIER tops the list. VE1EY keeps the Island on the map. VE1BV handled some death traffic. VE1CY would like reports on his official broadcasts. VE1EX and EB have tri-weekly schedules with the R.M. Congrats to VE1CI on new junior op. VE1CF has gone to sea. VE1AX finished the big outfit. WE1EP has increased power. VE1ET is making good use of FB location. VE1DQ is QRL fishing. BE1CR is servicing BCL sets. VE1CK blew an '81. VE1BN is kept busy winding transformers. Welcome is extended to the following new men: VE1BB, DX, and DN. VE1CL is strong supporter of 1.7 mc.

Traffic: VE1ER 214 EP 58 EX 23 CY 15 BV 8 BM 7 AL 4.

### ONTARIO DIVISION

ONTARIO — SCM, H. W. Bishop, VE3HB — VE3JI is new RM at Ottawa. VE3GI is applicant for ORS. VE3GA is QRL exams. 56 mc. stations in Toronto: VE3NO, NB, and YY. VE3LI has BCL trouble. VE3MX sends FB dope on club. VE3HN is home from Toronto. VE3PY is QRL work. VE3DX is QRL studies. VE3OZ is looking for a job. WE3CX and HA are back with OFB. VE3LY is looking after things while the RM is away. Mrs. VE3DW planned a surprise party on the OM. VE3CB paid a visit to Beansville. VE3WV received his first VK card. VE3HI is QRL 26 hrs. per diem. VE3NX schedules VE3QM. VE3IR has an FB note. VE3SG sends first report. VE3AD QTAed all schedules. VE3CX is op at VE3DT. VE3HU has plenty grief RC. VE3KN has found the spot in the band. VE3GB got his last stage neutralized. VE3FW is rebuilding garage. VE3PY expects to get a job with CNT. VE3IP "no can hear them." VE3OZ pounds away. VE3GS has big ideas annexing VE3G's pair 250 watters. VE3FS hangs on to the old call. VE3CH tends the dental trade. VE3RA tries for his commercial ticket. VE3MM received commercial tickets. VE3PQ moved QRA. New amateurs this month: VE3WS, JT, QP, EI, IQ, IY, HQ. VE3TM has Jan. QST receiver. VE3EP says traffic is on the wane. VE3QU, QE, QH, and MG are on regularly. VE3OF schedules VE3DW. VE3EB is QRL garden. VE3DD and GX have gone north. A blanket report on activities by the Publication Mgr. of the Queen City Amateur Radio Club (Toronto) includes reports on the following: VE3WK, LJ, NZ, NM, JO, MZ, SK, GI, MJ, EU, JH, II, IR, DY, CN, BK, HE, GM, RF, XB, XJ, GR, JM, JN, JG, FC. A fine show of activity. FB, OMs. (Please report via the SCM.)

Traffic: VE3AD 162 JI 133 DW 60 HP 55 TM 35 IH 31 HB 16 PQ-LY 15 LI 14 WK 13 WV 12 IR 9 QB 8 NQ 7 GI 5 JT 4 MX 1. VE9AL 18.

### QUEBEC DIVISION

QUEBEC — Acting SCM, John C. Stadler, VE2AP — VE2FE owns an FB7. VE2BE returned from the Board meeting. VE2CA handled important traffic. VE2BB, CX, CU and AP went to New England Convention. Welcome to VE2DU and DG. VE2AB and DB are moving to new QRA. VE2GE is taking portable to summer place.

VE2GM, FD and EH are busy with exams. VE2BD completely rebuilt. VE2DD is going crystal. VE2EY is on 14 mc. 'phone. VE2GF uses '46 throughout. VE2BO and CU are looking for jobs. VE2CD is proud owner of an SS. VE2FB is getting 56 mc. ready for plane work. VE2EM is busy with 3.5 mc. 'phone.

Traffic: VE2FE 34 BG 27 BB 42 CX 6 CA 5 AP 64.

### VANALTA DIVISION

ALBERTA — SCM, C. H. Harris. VE4HM — VE4BV is getting new receiver. VE4BZ has crystal going. VE4EA is making transmitter changes. VE4EO starts club at Lethbridge. VE4FJ reports new ham at Jasper. VE4GP. VE4FR is on weekends. VE4GT is QJRL insurance. VE4GY finds time for QSOs. VE4IZ has 50 wattter. VE4IP moved to Alliance. VE4FI and HW returned to Calgary. VE4EX is new YL at Edmonton. VE4HM's YF has schedules. VE4GD reduced power. WE4AX and AW are new hams at Calgary. VE4JK is on 3.5 mc. 'phone. VE4KQ is building 'phone. VE4HV, JW, JC and HQ are active.

Traffic: VE4BZ 111 EO 19 MG-HM 17.

BRITISH COLUMBIA — SCM, J. King Cavalsky, VE5AL — VE5AM is building new rig. VE5BI blew his '10s. VE5AG has gone to sea. VE5EU was a visitor in town. VE5EC is off schedules. VE5IE is going crystal. VE5JC is hot on DX. VE5EH is in town. VE5FF is on the move. VE5DK is new ham in Rossland. VE5AI is on 'phone. VE5BM schedules Victoria. VE5AJ is a new call.

Traffic: VE5AC 28 IM 50 DV 35 EC 30 HR-DF 27 HP 189 HJ 8 FG 3 GS 6 AL 29 CG 3 HQ 44.

### PRAIRIE DIVISION

MANITOBA — SCM, Reg Strong, VE4GC — The M.W.E.A. has had many favorable comments on the "Bull." VE4AK schedules AU and HE. VE4BT worked much DX. VE4MW relayed death message. VE4CI leads the DX hunt. VE4DK's fifty is deceased. VE4MY suggests using crystals for monies. VE4CD is a new-comer. VE4KU needs pair of tens. VE4IP is going east. VE4IC won a scholarship at McGill. VE4AG has written his commercial ticket. VE4IU and FT are QRL. VE4FP is O.O. VE4FJ has fishing tackle oscillating. VE4KY is active at signal corps station. VE4ZR is getting nearer d.c. VE4LH has new crystal job. VE4RC has a new aerial. VE4LT doesn't believe in crystals. VE4KX has heard cards from two VK and a ZL. VE4CP chews the rag at high speed. VE4FU keeps the new hams in line. VE4DJ should have call changed to "DX!"

Traffic: VE4BT 60 MW 58 AK 24 CI 20 DJ 9 KU 6 GC-MV 3.

SASKATCHEWAN — SCM, W. Skaife, VE4EL — VE4EU is a nice 'phone outfit on 1.7 mc. VE4AT hooked a VK. The SCM visited EU and AT. VE4GA knows how high a 250 wattter will bounce on concrete. VE4KV's receivers perk FB. How did VE4KR get his power supply for 1 Buck? VE4CM turns in nice traffic total. VE4JV has the power for a 50. VE4BM is going on Forestry station. VE4FH went to the coast. VE4HX has new power supply. VE4GR lost high voltage condenser. New Regina ham is VE4EB. VE4KE, LU, MD, and MT visited GA.

Traffic: VE4CM 200 BB 70 AT 53 GR 30 EL 23 AU 15.

### 28-MC. NOTES

W5BTW, Glen Rose, Texas, heard W5CGO and W9DEG on 28 mc. at 8:30 p.m. C.S.T., May 13. On May 14 he also heard W9MDO and X9A but believes they were 14 mc. harmonics. On May 7th W9GFZ, Wheaton, Ill., working on 28 mc., was QSO W5BTW at 9:45 a.m. C.S.T. On the same date W5BTW heard W9AGO QSO W9FQN. W9GFZ on 28 mc. has heard the 14 mc. harmonics of XDA, W2AU, W5AMC, W5CWQ, W5CUM, W9CDM, W9DNZ and WK1/WIU. W5BTW and W9GFZ will be on 28 mc. each week-end. It is suggested that stations working on 28 mc. sign "28 mc.," so that listeners may know they are not receiving "harmonics."

# • I. A. R. U. NEWS •

Devoted to the interests and activities of the  
**INTERNATIONAL AMATEUR RADIO UNION**

President: H. P. MAXIM

Vice-President: C. H. STEWART

Secretary: K. B. WARNER

Headquarters Society: THE AMERICAN RADIO RELAY LEAGUE, West Hartford, Conn.

## MEMBER SOCIETIES

American Radio Relay League  
Associazione Radiotecnica Italiana  
Canadian Section, A.R.R.L.  
Deutscher Amateur Sende-und-Empfangs  
Dienst  
Experimenterende Danske Radioamatører  
Liga Mexicana de Radio Experimentadores  
Nederlandsche Vereeniging voor Interna-  
tionaal Radioamateurisme

Nederlandsch-Indische Vereeniging Voor  
Internationaal Radioamateurisme  
New Zealand Association of Radio Trans-  
mitters  
Norsk Radio Reløis Ildg  
Polski Związek Krotkofalowców  
Radio Society of Great Britain  
Rede dos Emissores Portugueses

Reseau Belge  
Reseau Emetteurs Français  
South African Radio Relay League  
Suomen Radioamatööriiliid to r.y.  
Sveriges Sändareamatör  
Unión de Radioemisoros Españoles  
Union Schweiz Kurzwellen Amateur  
Wireless Institute of Australia  
Wireless Society of Ireland

Conducted by Clinton B. DeSoto

### General:

Amateur radio is scheduled to play an important part again in the third Belgian ascent into the stratosphere, which will this year be conducted personally by the brilliant young Belgian radio amateur and physicist, Max Cosyns, B9, assistant to Prof. Piccard, who accompanied the distinguished Belgian savant on the two previous flights. The ascent is now definitely scheduled for July from Hoar-Havenne in the province of Namen, although the exact date is not known at the time of writing. Experimental tests with various forms of radio equipment in aircraft are being conducted by Jacques Mahieu under the call XXON4AU, preliminary to the construction of the apparatus actually to be used in the stratosphere. The Reseau Belge and the A.R.R.L. have arranged cooperative schedules in connection with these tests, which are being conducted in the 7- and 14-mc. amateur bands.

Officially authorized by the Soviet government, amateurs in the U.S.S.R. are now using the prefix "U" in place of the previous "EU" for Europe and "AU" for Asia. This is in conformity with the table of call letter distribution adopted at the Madrid conference, to be generally effective the first of next year.

The R.S.G.B.'s recent 3.5 mc. contest was well supported, it is learned from J. Clarricoats, secretary, with the laurels going to Scotland. Jack Wyllie, G5YG, Scottish manager of the R.S.G.B., won first place with a score of 202 points. W. A. Clarke, G5FV, R. A. Bartlett, G6RB, and S. A. French, G6FN, were runners-up with scores of 163, 161 and 160 points respectively. Thus Scotland wins its third R.S.G.B. contest this season, the others being the 1.7 mc. and low power tests.

Quite a number of reports of inter-Antipodes overhearing on the 7-mc. band the long way 'round

have been elicited by recent comments on this subject in these columns. The term "long way around" is used advisedly: some are inclined to insist that the signals travelled through the daylight zone. At any rate, it is all highly interesting evidence, more effective than any amount of theory or words, that radio conditions are again approaching those of ten or eleven years ago.

### National:

In continuation of the series of articles on the national member-societies of the Union, we present this month the following account of the development and growth of amateur radio organization in South Africa.

### Amateur Radio in South Africa

By R. C. H. Taylor, Honorary Secretary, S.A.R.R.L.

AS IN the case of most of our sister societies, organized amateur activity in this country is of comparatively short duration. At the same time it is interesting to note the several phases of radio development which led up to the formation of the South African Radio Relay League in 1925.

With this in view we go back to the period of the Boer War (1899-1902), when military operations were assisted by the use of several field stations, though no record can be found to show that this service was of material advantage.

Of amateur activity at this period there is no evidence and it is not until 1912 that we learn of isolated groups of amateurs working "spark" in several of the larger towns. Contact between stations more than a few miles apart was out of the question and no attempt was made to organize on lines such as we have today.

The advent of the Great War, of course, saw the immediate cessation of all amateur activity,

and there the thread of the story is lost for the time being.

In 1924 we find 21 licensed amateur transmitters in the Union of South Africa and Rhodesia, several of whom, even at this early stage, were experimenting with telephony. Their efforts, while lacking greatly in the technique which is characteristic of modern high-quality transmission, were nevertheless received and enjoyed over



**OB2SK, THE THOUSAND-MILE-PER-WATT STATION OF HORACE G. GRAY AT SARAWAK**

*With seven watts maximum input, the world was worked from the wilds of Borneo.*

a surprisingly wide range by listeners in. (Commercial broadcasting commenced in June 1924 with regular nightly programmes from the Johannesburg station. Undoubtedly the efforts of our pioneers paved the way for this service by whetting the public appetite and showing just what could be done even with the limited apparatus then available).

It was not until the publication in May 1924 of "Radio," South Africa's first radio journal, that the question of organizing began to be considered. It is certain that the S.A.R.R.L. owes its existence to the efforts of Messrs. Raymond Coombs and L. E. Green, of the editorial staff of that paper. These two pioneers soon collected around them a nucleus of prominent experimenters and the South African Radio Relay League came into being, membership being strictly limited to those holding transmitting licenses. The wisdom of this exclusive policy subsequently became evident when many of the BCL radio societies, which were formed about this time, petered out after a brief career.

By May of 1925 the organization had been considerably increased and the sub-continent split up into territorial divisions extending as far north as Kenya and Uganda.

One of the first official acts was the relay of royal greetings via amateur stations to H.R.H. The Prince of Wales, K.G., on the occasion of his visit to South Africa.

In June 1925 international radio history was made when Streeter, A4Z, established the first DX contact with Braggio, CBS, of Buenos Aires.

About this time the ranks of the League were thrown open to any person not in possession of a transmitting license but professing a genuine interest in the science of radio.

In January, 1926, Mr. Joseph White, M.C., A.M.I.E.E., accepted the office of President and it is pleasing to record that he holds this position today. To him the League owes a great debt on account of the skillful way in which he has guided its destinies through troublous and disheartening times.

During September and October of 1926 an event took place, the recounting of which will be of interest to readers of *QST*. This was the Silver Springbok Contest in the course of which amateurs throughout the United States concentrated on effecting two-way contacts with South Africa. The event was won by Borden, U-1CMX, with some 35 contacts to his credit, while in South Africa, Marks, A3B, topped the list with 307 American contacts. The prize of a silver springbok was duly presented by the editor of the "Rand Daily Mail" to 1CMX.

We come now to a consideration of present phases of the League's activities, and it is fitting that a word should be said at this stage regarding the government of this organization of ours. As has already been stated, the sub-continent was originally split up into a number of territorial divisions the headquarters of which were situated at convenient points. The control of each of these territories was vested in a committee, the chairman of which was also a member of the Executive Committee at League Headquarters in Johannesburg. In view of the fact that in most cases he was resident hundreds of miles away and unable to attend meetings at Headquarters, a proxy assumed his place on the central executive. The weaknesses of this system very soon became apparent. It was impossible for the proxy to function satisfactorily. Whenever business of importance came before the executive it had to be referred back to Divisions before it could finally be voted on and disposed of. For years agitation against this system continued, sponsored by those who suffered most under its limitations. Eventually, early in 1932, an entirely new constitution was adopted, and so far has proved most satisfactory. Supreme control is now vested in a council which meets monthly at League Headquarters in Johannesburg, and is elected annually by ballot of the membership. The Divisional committees continue to function as before.

The business of the League is conducted by honorary officials, whose spare time is almost entirely devoted to the work.

Membership is divided into four grades: Full, Associate, Empire (applicable to British subjects resident outside the Union of South Africa), and

Foreign. The number of members today remains fairly steady at about 400, of whom, it is pleasing to note, a fair percentage are amateurs in other parts of the world, including Great Britain and the United States. This fact is particularly gratifying to us in view of the greater facilities offered by Societies overseas.

The League's development has been bound up largely with that of its news-organ. In 1926 the "FO Bulletin" made its first appearance and was extremely well received by the scattered membership. It consisted of four mimeographed sheets and was published fortnightly. After an honorable life it was superseded by a printed journal, *QTC*, published monthly, which, in its fifth year, continues to flourish and finds its way into all parts of the world. It is surprising how this little 20 page publication has won through despite a world depression and consequent decrease in revenue. To *QTC* goes the honor of being (we believe) the only ham journal to have had one of its editorials reproduced in full in the columns of *QST*!

Contests are frequently held. Three floating trophies change hands annually. They are the HOS Trof, donated by Mr. Raymond Coombs; the C and B Trophy, awarded to the amateur who performs the most meritorious feat of the year; and the Akyab Trophy. The C and B Trophy has been held both by Mr. Macgregor, the first South African to effect contact with New Zealand in the "good old days," and Mr. Drennan, who gave 10-metre work a great fillip by working Germany at a time when very little was known about this band.

A recent contest which aroused considerable interest was a relay of messages through each of the five territorial divisions which comprise the Union. The best time put up was 2½ hours, which is remarkable in view of the natural disabilities at present affecting short distance work.

South Africa by virtue of her geographical position can truly be said to be unique in that at times radio conditions prevail which are found in no other parts of the world. An analysis of the bands is instructive:

160 meters: Very seldom used.

80 meters: Unusable during summer on account of constant and terrific QRN. Enjoys a fair measure of popularity during winter when conditions prevent local contacts on higher frequencies.

40 meters: Generally recognized as the most popular band for all-round working. During winter months signals on this band from stations between 10 and 500 miles away often fade out suddenly at sunset and do not reappear until the following morning. This phenomenon when it first appeared caused quite a little consternation in the fold.

20 meters: Used for DX contacts in a few iso-

lated instances. Was a most popular band a few years ago.

10 meters: Not used at all at the time of writing.

5 meters: Considerable interest in this band has been aroused by the publication of results achieved in Europe and America. Unfortunately it has not as yet achieved the popularity it deserves. More organized investigation is sadly needed.

As is generally the case throughout the British Empire, the control of the communications system is a government monopoly. Amateur transmissions are therefore confined to messages concerning the experiments in hand. An interesting development, however, is the Emergency Communications Scheme under which a number of picked stations, all members of the S.A.R.R.L., are handling traffic connected with the administration of the League and its divisions. This system is sponsored by the Department of Defence and already a traffic network is in existence which can at a moment's notice be placed at the disposal of the authorities in time of stress or national disaster. So reliable has this network become that gradually all correspondence connected with the administration of the S.A.R.R.L. has been diverted to it from the postal system, special permission for this having been granted by the Postmaster-General.

South African amateurs have reason to congratulate themselves on the attitude adopted by the Postmaster-General who has on many occasions shown himself as sympathetically disposed towards amateur operation. None of the bands laid down at Washington have been curtailed, except in the case of 40 meters where the use of telephony is somewhat restricted. The Department of Posts and Telegraphs has taken a keen interest in special amateur experiments and on several occasions has consulted the League in connection with local technical difficulties. This co-operation is particularly appreciated.

Telephony has been a feature of local amateur operation for at least eight years. From time to time it has achieved a wave of popularity when every second station on the air was modulating with voice. Generally speaking, however, the quality has been of a low standard.

In conclusion, may we add that nothing gives us greater pleasure than to have the opportunity of meeting and entertaining brother amateurs from other shores? We sincerely trust that those who contemplate visiting this country will not omit to advise us of the fact in order that we may kill the fatted calf and get the beer on ice!

## Strays

W5BSK suggests tacking tinned braid around the wooden transmitter frames that many hams use. Grounds can be made to the braid just as conveniently as to the regular metal frames.

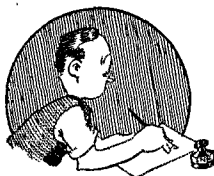

# CORRESPONDENCE

The Publishers of QST assume no responsibility for statements made herein by correspondents

## Pre-War Stuff

Columbus, Ga.

Editor, QST:

I have read with increasing interest the several letters and articles of old timers who recall those halcyon days when spark reigned supreme. To me there has always been a great respect for the spark, whether a ten-inch Marconi coil, the rotary or the quenched gap. Few of us old timers have forgotten the joy of getting that "pure d.c." touch to an old ten-inch coil grunt, or that melodious hum of the rotary doing its stuff. What a kick I got when I first heard Von Lepel's whistling arc, on which he played all kinds of tunes — not to forget Poulsen's arc.

My first "wireless" days were in 1908, when I learned the intricate art of the work. My first assignment was aboard the *Empress of Britain* in 1909 as second operator, with Fred Beatson, a Scot who loved his wee doch and dorach, as my senior operator. On this 18,000-ton ship, our rig consisted of a Marconi ten-inch spark coil, huge Leyden jars and a Maggie detector. For long distance to get press from Poldhu and WCC we had a receiving inductance that stood four feet high on the table to the left and contained miles of wire, I expect. Some of you OT's will remember that this was about the time that Jack Binns had saved the Republic. It was a very puffed up second operator who strutted the decks in his white uniform and gold braid, to hear the passengers whisper to each other: "There goes the only man who can save the ship after the Captain gives up hope." Did I strut? Shall I ever forget the day when Capt. Murray brought the Earl and Countess of Macclesfield into the radio room to see the wonders thereof, when the Skipper accidentally sat on the key just as Beatson had grabbed hold of a brass rod to disconnect the sending set from the receiver; how he yelled a terrific oath as he got the full charge of about 30,000 volts and jumped six feet back and put his head through a glass chart on the wall. It took several whiskeys at the Skipper's expense to revive him!!

I notice a reference in January issue to the United Wireless Company. I wonder if the writer remembers the grand old feud between the United Wireless and the Clark Wireless Company centering around Lake Erie. Whenever one of them would start operating, the Buffalo station had a tank of brine in which were two electrodes.

The operator just screwed the key down and the brine solution and electrodes did the rest. If I remember rightly this jamming kept up by the hour on end. Not much traffic got through when those boys were on the job.

I wonder how many OT's remember the 5-kw. Telefunken station that I worked on for a summer on the top of the T. Eaton store in Toronto. DX with 5 kw? Why, old boy, I could even get Tobermory on the Georgian Bay, 200 miles away. My old friend Keith Russell of Toronto used to work a Clapp-Eastham quenched gap Hi-Tone set that used to be the delight of my life. So did Conway Todd while I worked on VGU, the *Ontario No. 1* on Lake Ontario, using a S.F.R. transmitter and receiver, with a 1000-cycle alternator and an air-blown gap. I worked New York, WSK Siasconsett I think, on that set one dark night.

Then do you recall the war days when sigs were reduced to a minimum? What a torment the American ship operators used to be to those who were not used to their dragging style of sending, as we labored on His Britannic Majesty's Naval Stations off the coast of Nova Scotia with a ten-inch spark coil for short distance and a two kw. rotary for DX. Oh boy! Do I get a laugh out of it all as I look back! Would you believe me if I told you that before I went afloat in 1909 I knew the call sign of every ship on the Atlantic? That was required before going out.

Yours for DX and fond memories of the past,  
— *Geoffrey Hinshelwood, W4BBV*

## Ham Publications

408 Sicily Ave., Ravenna, Nebr.

Editor, QST:

Just how many ham sheets in these United States can be considered successful? I refer to the smaller publications edited for the purpose of disclosing the activities of amateurs within a limited area.

During the past two years I have subscribed to several such publications. Not one of these was successful, and all were discontinued before the subscription had been fulfilled. Such business as this certainly does not promote good will between the subscriber and the publisher and it tends to destroy faith in these publications, which are in reality a wonderful asset to the amateur.

What would the American Radio Relay League



# NATIONAL

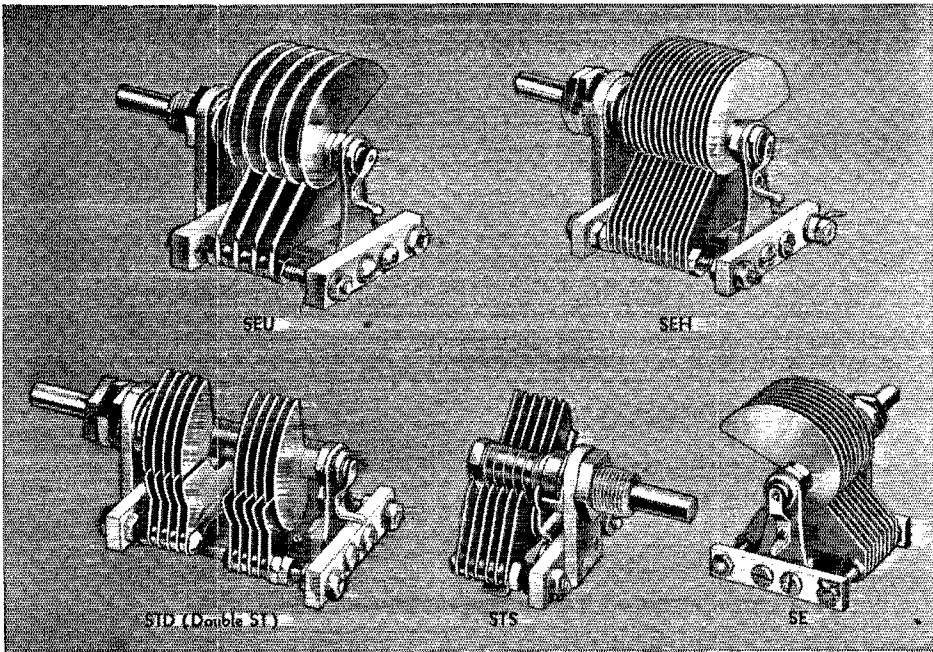

## LAST MONTH

on this page, we pointed out a number of design features — such as Isolantite Stator Insulation, thick aluminum plates, constant impedance pigtail, insulated bearings — which are in part responsible for the wide acceptance of NATIONAL condensers as a standard of quality.

Most amateurs with a keen technical interest in the art know what these refinements offer, but many have made the pardonable mistake of feeling the price must be prohibitive.

So let's consider price. From the wide selection tabulated, pick a popular size, such as ST-100, with 100 mmf. capacity and 180° rotation, and note the very modest list price of \$2.25, to which the usual discounts apply.

And to make a thoroughly convincing comparison, go to your dealers and see one. Compare it, detail for detail, dollar for dollar, with any competitive make.

When you have done this, you will know why communication engineers and advanced amateurs have specified National ultra-high-frequency condensers for years.

Catalog Type No.	Capacity in Mmf.	Air Gap	Plate Shape	Rotor Plates	Stator Plates	Depth behind Panel	List Price
ST- 50	50	.026	180° SLW	6	5	2 1/4"	\$1.80
75	75	.026		8	7	"	2.00
100	100	.026		10	10	"	2.25
150	150	.026		15	14	2 3/4"	2.50
200	200	.0175		14	13	2 1/2"	2.75
250	250	.0175		16	16	2 3/4"	3.00
300	300	.0175	20	19	2 3/4"	3.25	
335	335	.0175	22	21	2 3/4"	3.50	
STN- 18	18†	.065	4	3	1 3/4"	2.00	
STHS- 15	15	.0175	2	1	"	1.40	
25	25	.0175	2	2	"	1.50	
50	50	.0175	4	3	"	1.60	
STD- 50	50*	.026	6*	5*	2 3/4"	3.50	
STHD-100	100*	.0175	7*	7*	"	4.50	
SS- 50	50	.026	180° SLC	5	4	2 1/4"	\$1.80
75	75	.026		7	6	"	2.00
100	100	.026		9	8	"	2.25
150	150	.026		12	12	2 3/4"	2.50
SSH- 200	200	.0175		11	10	2 1/2"	2.75
250	250	.0175		13	13	"	3.00
300	300	.0175	16	15	2 3/4"	3.25	
350	350	.0175	18	18	2 3/4"	3.50	
SSN- 18	18†	.065	3	3	1 3/4"	2.00	
SSS- 20	20	.0175	1	2	"	1.40	
30	30	.0175	2	2	"	1.50	
50	50	.0175	3	3	"	1.60	
SSD- 50	50*	.026	5*	4*	2 3/4"	3.50	
SSHD-100	100*	.0175	5*	5*	2 3/4"	4.50	
150	150*	.0175	8*	8*	"	5.00	
SE- 50	50	.026	270° SFL	6	5	2 1/4"	\$3.00
75	75	.026		8	7	"	3.25
100	100	.026		10	10	"	3.50
150	150	.026		15	14	2 3/4"	3.75
SEH- 200	200	.0175		14	13	2 1/2"	3.75
250	250	.0175		16	16	2 3/4"	4.00
300	300	.0175	20	19	2 3/4"	4.00	
335	335	.0175	22	21	2 3/4"	4.25	
SEU- 15	15	.055	3	3	"	2.50	
20	20	.055	4	4	"	2.75	
25	25	.055	5	4	"	2.75	
2SE- 100	100*	.026	10	10	5"	5.50	
2SEH- 200	200*	.0175	14	13	"	6.50	
2SEH- 335	335*	.0175	22	21	"	6.75	

\*Per Section

†3000 Volt Rating

‡Usual Trade Discounts Apply



**NATIONAL COMPANY, INC., MALDEN, MASS.**

Say You Saw It in QST — It Identifies You and Helps QST

# To Our Readers who are not A.R.R.L. members

**Y**OU should become a member of the League! That you are interested in amateur radio is shown by your reading of *QST*. From it you have gained a knowledge of the nature of the League and what it does, and you have read its purposes as set forth on the page opposite the editorial page of this issue. We should like to have you become a full-fledged member and add your strength to ours in the things we are undertaking for Amateur Radio. You will have *QST* delivered at your door each month. A convenient application form is printed below — clip it out and mail it today.

*A bona fide interest in amateur radio is the only essential qualification for membership*

AMERICAN RADIO RELAY LEAGUE  
West Hartford, Conn., U. S. A.

I hereby apply for membership in the American Radio Relay League, and enclose \$2.50 (\$3.00 outside of the United States and its Possessions, and Canada) in payment of one year's dues, \$1.25 of which is for a subscription to *QST* for the same period. Please begin my subscription with the ..... issue. Mail my Certificate of Membership and send *QST* to the following name and address.

.....

.....

.....

Do you know a friend who is also interested in Amateur Radio, whose name you might give us so we may send him a sample copy of *QST*?

.....

*Thanks*

be without *QST*? The U.S.N.R. of the Ninth Naval District have their *QRX* and the A.A.R.S. of the Seventh Corps Area have their *Time*. These publications have aided greatly in forming these iron-clad organizations, so why couldn't a successful publication do likewise for local organizations?

To prevent any further destruction of faith in amateur publications, I suggest that anybody proposing such a publication have sufficient funds to promote it and not have to depend entirely upon the proceeds of the subscriptions. If such a procedure is necessitated, then it would be better for the publisher to charge a higher rate for the subscription than to charge a low rate and fail.

— Clyde D. Smith, W9DFP, W6ESC

## Using the Head

1406 Butternut St., Syracuse, N. Y.

Editor, *QST*:

Without doubt you are familiar with the fact that no two amateurs will build the same unit in exactly the same way, and also that an article appearing in *QST* will surely be revised to suit the requirements of the individual. Along these lines let me submit to you certain refinements which have been incorporated into the more popular transmitting circuits by the amateurs in this area.

At the time that the push-pull 45 transmitter came along, it was immediately accepted by a number of the fellows around here, and worked very FB. The natural thing to do was to increase power, use larger tubes, and get out better. But that's where the rub came in. Most of us didn't get out better. A change to 203-A's in the same circuit did not justify itself as far as results were concerned. What's to do about it, let's put out the lights and go to bed? I guess not. Digging around in *QST* files looking for push-pull articles we find one applying this circuit to 852's. The first difference that strikes the eye is that of the plate tank tuning arrangement. We read that a double-section condenser is necessary to balance up both sides of this circuit, so let's go and see how our present single-section condenser is acting. Testing with a neon bulb the glow on one side is fully double that on the other. Reversing the rotor and stator connections to the tank condenser reverses the hot side of the circuit. It is possible to get the two sides nearly even by adjusting the feed point with our coil center tap clip, but this point is nearly two turns off. Having decided that we need a split condenser we proceed to cobble the one we have or else get another one. We hook it up as shown in the 852 diagram and discover that our plate coil is too small. The new coil is made and inserted and again we're ready to steamboat. This time things act normal, and the note in the monitor is much smoother. Also the output has gone up. Guess that's because the r.f. choke that's been giving us such a headache is working at last. And so it goes. The whole set is designed to conform to the higher power and the results are at last gratifying.

# VACATION SALE for July only!

## THE NEW "20-W JR." Crystal Controlled Transmitter Kit, \$10.95

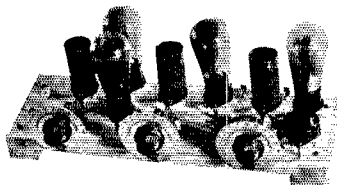

This efficient little transmitter is very low priced, making it possible for anyone to use crystal control at less than it would cost you to get the parts together for a self excited rig of this type. The "20-W Jr." is simple to wire and get on the air and the most inexperienced operator will have success with it. The size of the transmitter is only 6" x 17" and is therefore suitable for portable use. Only one milliammeter is required for tuning the transmitter and jacks are provided for this purpose, for each stage. The plug-in crystal holder is supplied with the kit at no additional cost. The "20-W Jr." uses one '47 as crystal oscillator, one '46 as buffer or doubler and two '46's in the amplifier. One set of three coils is supplied with the kit for either 20, 40, or 80 meters, 50 cents extra for the set of 160 meter coils. When ordering mention your choice of coils.

80 or 160 meter X cut crystals supplied for only \$2.75 if purchased with the "20-W Jr." kit. Hoyt milliammeter if purchased with the kit only \$1.25

## The "EAGLE" Three-Tube Short Wave Receiver

Only finest material used thruout — employs one '32 R.F., one '32 Detector and one '33 Pentode Audio — 15 to 200 meters — four coils supplied. The "Eagle" is economical — two dry cells will operate the filaments. See March or April QST for full description on this most excellent value in short wave receivers.

"Eagle" Completely Wired and Tested... **\$10.95**

Three Tubes Tested in Your Receiver.... **\$3.00**

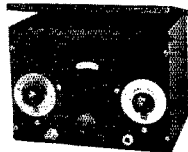

### PRICES GREATLY REDUCED

Ward Leonard Vitreous Resistors  
200-Watt Type 8 1/2" Long with Variable Sliders.

1000 ohms.....	\$ .99
2500 ohms.....	1.05
5000 ohms.....	1.05
10000 ohms.....	1.11
15000 ohms.....	1.20
25000 ohms.....	1.29
35000 ohms.....	1.35
50000 ohms.....	1.44
60000 ohms.....	1.44
80000 ohms.....	1.44
100000 ohms.....	1.44

### 15-WATT, WIRE WOUND 2" PIGTAILS

7500-10000-12500-15000-20000-25000-30000-35000-40000-50000 ohms... **\$.25**

### BLACK SHRIVEL FINISH SHIELD BOXES

with slip on covers. Dress up your equipment and give it that commercial appearance.

Length	Height	Width	Price
6"	5"	5"	\$ .65
9"	6"	5"	1.25
10"	7"	9"	1.60
14"	8"	10"	1.90

### CRYSTALLIZED FINISH RELAY RACKS

40" high including panels..... **\$12.50**  
60" high including panels..... **14.75**

### STAR MIDGET VARIABLE CONDENSERS

.000015 mmf.....	\$ .49
.000025 mmf.....	.49
.000050 mmf.....	.54
.000100 mmf.....	.59

### REDUCED PRICES

2.5 V. 6 amp. C.T. (midget).....	\$ .80
5 V. 3 amp. C.T. for '83 (midget) ...	.80
2 1/2-2 1/2 and 5 Volt C.T.....	1.15
2 1/2-7 1/2 and 7 1/2 Volt C.T.....	1.35
2 1/2-5 and 7 1/2 Volt C.T.....	1.35
5-5 and 5 Volt C.T.....	1.35
5-7 1/2 and 7 1/2 Volt C.T.....	1.35
Thord. 30 H 75 MA.....	.55
Thord. 15 H 250 MA.....	3.25
Thord. 30 H 500 MA.....	8.50
500 H. plate chokes for Screen Grid detectors (cased).....	\$ .95

### HOYT ANTENNA METERS

Hot wire antenna meters, 1 1/2, 3 and 5 ampere ranges. Why do without antenna meters when you can buy them at this Special price?..... **\$2.85**

HOYT perfectly damped meters at a price. These are not to be confused with the usual meter "bargains." 2" mounting hole, flange 2 1/2" diameter, supplied in the following sizes: 10 m.a., 50 m.a., 100 m.a., 150 m.a., 250 m.a., 300 m.a., 4 volt A.C., 10 volt A.C., 15 volt A.C., 40 v. D.C. Price each, **\$1.40**, 3 for **\$3.75**.

Burgess 45 V. No. 2308 Batt.....	\$ .95
Tiny-mite 1/2" stand-off Ins.....	.05
Egg Strain insulators.....	20 for .25
Bee hive stand-off ins. Per doz.....	.50
3" Isolantite spreaders.....	10 for .35
Jewel Pilot lights, red, green.....	.20
Double-button mike transformer.....	.95
5-meter oscillator coils.....	.65
Frost 500,000 ohm Potent.....	.35
Special plug-in type crystal holders. Extra special.....	\$ .89
5-slot wood choke forms.....	.06
.01 tubulars, 1500 V. Test.....	.15
1 1/2 volt keying relays. Special.....	.55

### GROSS

#### Special Power Transformer

for use with '83 tube will give an output of 500 volts D.C. at 350 MA with choke input. Run your entire R.F. and Class B off this transformer. The regulation for the class B is about 5%, filaments are two 7 1/2 v. and one 5 v. *Special*..... **\$5.75**  
A transformer having the same filament windings as above — at 300 MA having 750 volts each side of C.T.

*Special*..... **\$5.75**  
750-1000 V. each side of C.T. 300 watts. Extra special..... **\$6.50**  
High grade filament transformers shielded in metal cases, center tapped secondaries 2.5 volt 10 amperes for 866's, 10 to 12 volts at 8 amperes — either type..... **\$2.35**  
Special — 10 to 12 volt 7.5 amp. filament transformer, extra special..... **\$8.85**

#### CARDWELL CONDENSERS

123-B .0005 mmf.....	\$2.35
164-B .00022 mmf.....	\$2.35
147-B .00044 mmf.....	\$4.10
T-199 .00033 mmf.....	\$5.88
T-183 .00011 mmf.....	\$5.30

#### GUARANTEED TUBES

Heavy Duty Isolantite top 866.....	\$2.15
888 or 871.....	1.15
83 and 47's.....	.80
281 Plain.....	.90
210's.....	1.30
DeForest 46's.....	.60
DeForest 410's.....	1.15

Stranded about 6 guage 7/16 Silicon Bronze antenna wire hard drawn — won't stretch. **\$2.00** per 100 ft.

## "GC 30" SERIES XTAL TRANSMITTERS SEE MAY QST Write for data

20% deposit with all C. O. D. orders. Remit by M. O. Include Postage.

**GROSS RADIO INC.** 51 VESEY ST., N. Y. C.  
TEL. BARCLAY 7-0161

# TO

save yourself 50c a year (newsstand copies cost \$3)

get your copy of QST first

be sure of getting your copy (newsstands often sold out)

be eligible for appointment or election to A.R.R.L. offices

be eligible to sign petitions for your Director, your representative on the A.R.R.L. Board

be eligible to vote for Director and Section Comm. Manager (only A.R.R.L. members receive ballots)

lend the strength of your support to the organization which represents YOU at Madrid, at Washington — at all important radio conferences

have YOUR part in the A.R.R.L., which has at heart the welfare of all amateurs

Use the application blank on page 64 of this issue.

Recently a mighty fine little rig appeared in QST that struck my fancy. I'm referring to the 47 crystal oscillator and 46 doubler. BUT I don't want a doubler, what I want is an amplifier. So I dig up the dope on the 46, and go around asking questions of W8CYT, W8CP, and W8CDB. Talk about your divided opinions! Where one says the two grids should be tied together, the other says the inner grid should go to plate. At any rate I build the thing (changed to suit my individual taste) using series plate feed. That's because I feel the chokes will be more efficient. Secondly there is a choke in the crystal circuit. Thanks to W8CYT I put that in right off the bat, and W8CP found his crystal wouldn't oscillate without it. From any literature I can find on the 46 it says that this tube needs no bias. Having tried it from no bias in thousand-ohm stages up to ten thousand, I found that two thousand ohms was what I wanted to use. Note that I didn't say that that value was correct. Not being a radio engineer, I can only cut and try, and then use what strikes me as being best in my rig. Also having watched the inner grid in a 46 burn out when it was tied to the plate in a rig that W8AXC was building I decided to use it with both grids tied together. W8AXC is now using this circuit with a Type 10 as amplifier. Mine is a 46. His puts out more wallop, but mine bothers the BCL's less. There you are and take your pick. This is written just to suggest that things can be done to adopt any circuit to any need, and possibly to assist some in making changes.

— Arnold M. Weichert, W8AOW-GNW

# HURRY

## THROUGH

## TO THE

# BACK COVER

## BIG

# NEWS!

## Counting Messages

516 N. Harvard Blvd., Los Angeles, Calif.

Editor, QST:

I wish to offer a suggestion that I believe would greatly reduce the number of non-deliveries of messages.

The weak point in the present system is the crediting of two messages to a station that relays a message. It is much easier to pass a message along for some other chap to deliver than to mail it. Ships at sea relay traffic without charging for two messages and I see no reason why the amateur should collect double credit for a QSP.

The man who delivers messages can make the BPL more easily, you may say, but he deserves it for his expense on postage and trouble in mailing. An impressive total tickles some amateurs' vanities and relaying certainly inflates their totals. I have known selfish hams to hand messages around the city to all of their friends so the section in which they were operating could have a large total! Under the present system a message can barge around the country for weeks, so long as each station clears it within 48 hours, and still credit each station with two messages. There is greater chance for error, passing through so many hands, and eventually



A.R.R.L. Letterheads. Write your radio letters on League stationery—it identifies you. Lithographed on  $8\frac{1}{2} \times 11$  heavy bond paper. Postpaid. 100 sheets, 50c; 250 sheets, \$1.00; 500 sheets, \$1.75.

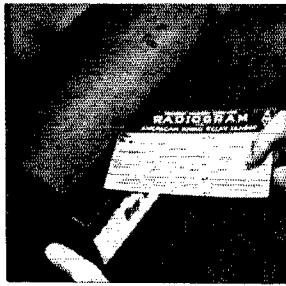

Message Delivery Cards. Neatest, simplest way to deliver a message to a near-by town. On U. S. stamped postals 2c each. On plain cards (for Canada, etc.) 1c each, postpaid.

## STATION SUPPLIES

Message Blanks. Most convenient form. Designed by the Communications Department of the A.R.R.L. Well printed on good bond paper. Size  $8\frac{1}{2} \times 7\frac{1}{4}$ . Put up in pads of 100 sheets. One pad postpaid for 35c or three pads for \$1.00.

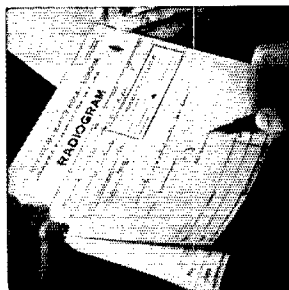

Log Books. Book with heavy paper covers.  $8\frac{1}{2} \times 10\frac{3}{4}$ . Contains 39 log pages, like below, and 39 blank pages for miscellaneous notes. Also list of Q sigs, message number sheet and sheet of cross-section paper. 40c each or 3 for \$1.00. Postpaid.

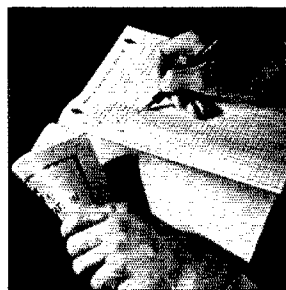

**THE AMERICAN RADIO  
RELAY LEAGUE, INC.**

WEST HARTFORD, CONN., U. S. A.



McMURDO-SILVER

## THE HAM SUPER IS HOT . . . AND HOW!

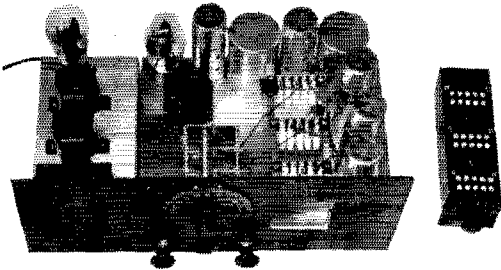

If YOU WANT TO KNOW about the hottest receiver on the market today, better find out about the set about which W9DF, 9AIG, 9PK, 9AFN, 9LW, 9CYE and more hams you know say "amazing . . . ten times as much DX . . . heard KA's, J's, AU's, VU's, YM's . . . worked VKZHQ and VKSHP between two locals . . . worked EAR46 just 500 cycles away from RXG without the least bit of interference."

And — designed by Fred Schnell, Bob Kruse and McMurdo-Silver, the Ham Super has been chosen for W9USA at the World's Fair.

Send a 3c stamp if you want to know about the cheapest and hottest ham receiver today, and other ham specials, such as a depression priced all A. G. frequency meter monitor.

### McMURDO-SILVER, INC.

1136 W. AUSTIN AVENUE

CHICAGO, ILLINOIS

## GULF RADIO SCHOOL

Radiotelegraphy Radiotelephony  
Radio Servicing

SECOND PORT } 1007 Carondelet Street  
U. S. A. } NEW ORLEANS, LA.

Learn at Home to be a

## Good Radio Operator

It's Easy

with  
The NEW MASTER



## Teleplex

### Code Teaching Machine

Pleasant, interesting work. An officer aboard ship. Opportunity to see the world and get paid for it. No experience necessary. We furnish a Complete Code Course and lend you The NEW MASTER TELEPLEX. Course prepared by leading authorities on the subject, makes learning easy as A B C. . . . TELEPLEX has instructed more students in code in the past ten years, than all other systems combined. . . . It is the only instrument ever produced that will record your own sending in visible dots and dashes, and then repeat it to you audibly on headphones. . . . Enables you to make your own records, as many as you want without extra cost. . . . Provides unlimited practice material. Used by U. S. Army and Navy, R. C. A., A. T. & T. Co. and principal schools. Get started on the code NOW! If you can already read the code we nick you up at your present speed. Easy terms. Write for folder Q-19 giving full details.

### TELEPLEX COMPANY

76 Cortlandt Street

New York, N. Y.

it may reach a non-A.R.R.L. operator who will throw it away because it is so old. If a message has reached the Continent it is intended for I believe it should be mailed within three days of its filing date!

A point which should be stressed is correct routing of traffic. If a message originates in New York for Los Angeles it should be relayed, not mailed, from Denver but one originating in Manila for New York should be mailed from Los Angeles to insure delivery and ample time will be saved.

I have held an ORS appointment and intend to apply for another one shortly but have often had better deliveries from non-ORS operators who had no ulterior motive in accepting messages. They would deliver instead of relaying traffic.

If amateur traffic handling is to serve public convenience it is the deliveries that count! If it is merely to have large numbers after station calls in *QST* the present system is flawless.

— Geo. Dery, W6HG, ex-WQBV

## Receivers vs. High Power

Herington, Kans.

Editor, *QST*:

For three years I have been content to read *QST* from cover to cover without the desire to voice any opinions of my own. I always enjoy reading the Correspondence Department, and have often wondered if that department is unpopular with the majority of the *QST* readers. It seems to me that if any thought at all is given to the numerous excellent letters that appear therein, there could not be such an utter disregard to so many of the finer considerations in amateur radio operating.

Let that be as it may. The purpose of this letter is not to cover old territory. It has been covered before, but not so often as the "Long CQ" topic, for instance. Here goes, so let's hope that someone will read this who will appreciate the sincerity with which it is written and act accordingly.

I have constructed my own version of Jim Lamb's new Single Signal Superhet. The crystal in the i.f. filter has been omitted for the present, and since 'phone is used mostly here at W9FVR, automatic volume control was added. The circuit diagram and specified constants were closely adhered to, with the result that the receiver far surpasses all expectations. It is after becoming thoroughly acquainted with this receiver that I feel justified in saying that the QRM situation in the present 'phone bands is due very much to the mistaken belief that a high-powered transmitter is the only requirement for "getting out" through the QRM — at the same time overlooking the fact another strong carrier on the already crowded band is only making matters worse, and that results will be obtained only as long as the average power used by amateurs remains less than our own power. When most of the boys

# AN INTRODUCTION TO AMATEUR RADIO . . .

— for the would-be amateur  
— for the ham who has a friend who wants  
to become an amateur

**T**HE second edition of "How to Become a Radio Amateur," in 32 pages, outlines the entire field of amateur radio. It makes learning the code easy, tells how to build a simple station, with clear illustrations and easily followed building instructions. And there's concise dope on getting licenses and operating properly, too. In short, it's an introduction to the art — thorough, yet simple.

Get introduced right now — or arrange an introduction for that would-be amateur friend of yours. Price 25c, postpaid. No stamps, please

**THE AMERICAN RADIO RELAY LEAGUE**  
WEST HARTFORD, CONNECTICUT, U. S. A.

## LOW RANGE FUSES

- *Littelfuses for Instruments:* Amps.: 1/100, 1/32, 1/16—20c ea. 1/8, 1/4, 3/8, 1/2—15c ea. 1, 2—10c ea. For milliammeters, ham rectifiers, etc. Use 1/8 for radio B circuits. *High Voltage Littelfuses:* 1000, 5000, 10,000 volt ranges in 1/16, 1/8, 1/4, 3/8, 1/2, 3/4, 1, 1 1/2, 2 amps. Renewable. Price 35c to \$1.25 ea. **NOW—\$100 PROTECTION GUARANTY.** Get New Cat.\*5.
- **LITTELFUSE LABS.** 1784 Wilson Ave., Chicago

*"Quicker than a Short circuit!"* **LITTELFUSES**

## GUARANTEED

**PARTS** Coupling chokes, audio, from screen-grid detectors, 32, 34, 57, 58, etc. to audio stage, \$1.05. No. 12 enameled aerial wire 48c per hundred. Feeder spreaders, light, high-grade porcelain, 7", 17c each, \$1.85 doz. FB-7 coils, sets, crystal filters, all National equipment in stock. Cunningham tubes. Big 210 tubes, large plates, \$1.47, 83's, 89c.

HATRY & YOUNG

HARTFORD, CONN.

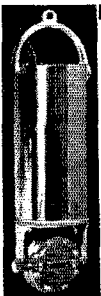

**New!**  
**Universal Model "E"**  
Condenser Type Microphone

Amazing quality at a sensationally low price. 90° Swivel Head with Automatic Barometric Adjustment — 2-Stage Amplifier — Non-Microphonic Tubes — Solid Bar Grating Diaphragm Protection — Polished Aluminum and Chrome Plated — At dealers' net cost of \$54.00, this is by all odds the greatest value in microphone history.

**UNIVERSAL MICROPHONE CO., Ltd.**  
424 Warren Lane Inglewood, Calif., U. S. A.

**PANELS—BAKELITE—RUBBER—ALUMINUM**  
All Sizes Cut to Order **BAKELITE TUBING & RODS**  
*Drilling, Engraving & Special Work*  
**ALUMINUM CANS**—6 x 5 x 9, \$1.70—6 x 10 x 7, \$2.75—7 x 9 x 14, \$4.45, and many other sizes. *Special sizes to order.*  
**ALUMINUM CHASSIS**—Threaded brass studs for 6/32 screws. Length from 1/4" to 6"—price 5c to 30c.  
Insulating bushings for all size shafts from 75c to \$1.90 per dozen  
Couplings in brass or bakelite —15c  
  
Mail orders filled same day. Transmitting frames and racks  
**UNITED RADIO MFG. CO., Est. 1923, 191 Greenwich St., New York**

## Classes Now Forming— ONE YEAR RESIDENCE COURSE In Practical Radio Engineering

The only radio course of its kind. Theory, practice all completely presented in 9 months . . . without the usual 4-year college preparation. Don't wait another minute — grasp this opportunity to study and work with the finest instructors and equipment in the country.

### REGISTRATIONS now ACCEPTED

Limited classes will force us to close applications soon. Classes begin shortly. Write today for information. No obligation.

Send for New  
**FREE CATALOG**

**CAPITOL RADIO ENGINEERING INST.**  
14th and Park Road Washington, D. C.  
Dept. QS-7

# CHI-RAD

## for EVERYTHING in Short Wave Equipment

The smartest "hams" know about this place to buy better equipment cheaper... why don't you get wise, too? F'rinstance:

### HAMMARLUND COMET "PRO"

A receiver too nationally well-known to require description or "sales talk" here... it's just that CHI-RAD can give you the best price!

### NATIONAL "FB-7" AND "FB-X"

A pair of receivers that are making short wavers talk! Get complete data from CHI-RAD, together with "low-down" prices that will please you.

### KITS

Yessir! We have that famous Wallace Hoover Prize-Cup Kit... an' ain't it somethin'? Get all details from us. All the other new, good kits, too!

### NEW '33 SHORT WAVE MANUAL

You're not a real "ham" without one... it's by Wallace, and represents a big-money value at \$1.00... better send for yours right now!

### ALUMINUM OR ELECTRALLOY PANELS

Cut to the size you want... and at mighty reasonable prices... Ask us!

Honestly, you ought to have the complete CHI-RAD loose-leaf catalog. Send 10c for it NOW!

**CHICAGO RADIO APPARATUS CO., INC.**  
412 S. Dearborn Street, Dept. Q-4, Chicago, Illinois

### Introductory 2-BUTTON MICROPHONE

*Special*  
A good, 200 ohms per button microphone at a low price. Pure gold contacts. Low hiss level. Duramin diaphragm. Scientifically damped. Frequency, 40 to 3500 cycles. Dia. 2 1/4", over all thickness 1", chromium finish, weighs 1 lb. packed. For any type mounting — desk, suspension ring, banquet. SPECIAL stand, sound truck, etc. A \$10.00 value for \$3.95. Send for catalog on other microphones and amplifiers. EACH  
**SOUND ENGINEERING CORP.**  
412 N. Leavitt St. Chicago

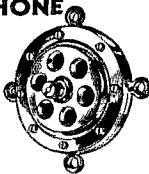

### RADIO ENGINEERING

RCA Institutes offers a combined course of high standard embracing all phases of Radio. Practical training with modern equipment at New York and Chicago schools. Also specialized courses and Home Study Courses under new "No obligation" plan. Address Dept. ST-7 for illustrated Catalog



**RCA INSTITUTES, INC. Dept. ST-7**  
75 Varick St., N. Y. 1154 Merchandise Mart, Chicago  
Recognized Standard in Radio Instruction Since 1909

## AMATEURS West of Rocky Mountains

We can supply all parts for  
the new circuits

Send for your Catalog of  
Nationally Advertised  
Transmitting and Receiving Parts  
at **LOWEST PRICES**

*Amateurs' Headquarters of the West*

### RADIO SUPPLY CO.

H. A. Demarest, *President*  
912-914 So. Broadway Los Angeles, California  
(W6FB1 located in Building)

(who have dough) are using the maximum power allowed to hams, what are they going to do next to pierce the QRM? When that time comes, surely they will realize their folly.

I find that with this receiver, about all that is necessary for reception is the presence of a carrier, be it ever so low in power. I have received 5- and 10-watt 'phones on both coasts on the 160-meter band, QSA5 early in the evening, when the high-power babies give them a chance to get through. I have also noted the instance where three DX stations were coming in QSA5, side by side, with no QRM to each other, when a 250-watt carrier came on top of them and put them clear out of the picture. The 250-watt carrier was some 600 miles away, and just a shade higher in frequency than the higher one of the other three. No more was heard of the other three stations until the high-power boy flopped his switches off again. Also, I have been able to receive good DX not more than 5 kc. removed from a 20-watt carrier from a station located just 12 miles from me. I have been able to hear *all districts* on 160 meters before 9 p. m. On my old receiver, a tuned r.f. job, I could hear only 9's and 5's consistently, with occasional reception of the higher powered 8's and an infrequent 2 or 3. Where I used to get nothing but a pile of heterodynes, I can now pick out readable stations.

The point is this. *Receiver sensitivity and selectivity can be increased to an unknown limit without adding to the present QRM. Transmitter power can be increased only to a very definite limit, with the sorrowful result now evident on the ham bands.* To you fellows with the jack, if you must spend it spend it on receivers; give the 10- and 20-watt 'phone a chance, and note the improvement in the QRM situation. The transmitter power at W9FVR is about 25 watts. Since putting the super into use, the number of contacts has been increased some fifty per cent. The same might have been accomplished by increasing the transmitter power, but no additional QRM has been caused, and a genuine feeling of pleasure is experienced with each QSO that would have been impossible with the old tuned r.f. job. With a good receiver, a 10- to 20-watt carrier is ample to reach any place in the good old U.S.A., so all power over that amount is good for nothing but QRM.

Whatever happened to the idea of the "High Power Holiday"? Let's have it — by making high-power unnecessary.

— E. R. Jensen, W9FVR

### Five-Meter Fone

12 N. Westminster Ave., Greensburg, Penn.  
Editor, *QST*:

"Five-meter fone, just some more of that ultra-high-frequency stuff. You can't work anybody with it." And with some such remark the ham turns to more interesting pages of *QST*. How many times have you hams said the above? The OM used to say it every time he ran across



**IN STOCK**

**FOR IMMEDIATE DELIVERY**

*The New*

**WESTINGHOUSE METERS**

*(See page 2)*

**FEDERAL TRANSMITTER TUBE**

**HAMMARLUND "PRO"**

**FLERON TRANSPOSITION BLOCKS**

(15c each, 8 for a dollar)

**BILEY "X" CUT XTALS**

(\$4.50 for 40, 80 or 160 M.)

**THIS MONTH'S SPECIALS**

**Oil Impregnated Filter Cond.**

C.C. of Amer. 4000 v. — 1 mfd . . . . . \$9.00

3000 v. — 1 mfd. . . . . 7.50

No. 10 Enamelled Ant. Wire. . . . . 70c 100 ft.

Small Power Transformer Pri. 110 v., sec. 2½,  
5, 375 v. . . . . \$1.00

Baldwin Type C Headset . . . . . \$3.25

**KALTMAN & ROMANDER**

62 Court St., Newark, N. J. Tel. MA 3-2020

**PUBLICATIONS**  
**No. 9 and No. 10**

OF

**THE RADIO AMATEUR'S**  
**LIBRARY**

*See inside front cover this issue*

**PRECISION CRYSTALS**

High Output Accurately Calibrated  
FREE Plugin, dustproof holder, with G. R. plugs, given  
with each crystal purchased.

PRECISION Crystals are X cut, one inch square, from the  
best grade of Brazilian quartz. They are accurately ground  
for maximum output, thoroughly tested and fully guaranteed.  
A calibration is furnished accurate to within 0.05%. These  
crystals are well known for their high quality.

1750 kc. band within 2 kc. of your specified frequency... \$4.50

3500 kc. band within 4 kc. of your specified frequency... 4.50

7000 kc. band within 20 kc. of your specified frequency.. 5.50

7000 kc. band within 7 kc. of your special frequency.. 6.50

Plugin, dustproof holder with G. R. plugs..... 1.50

*(This holder is given free with each crystal purchased)*

Temperature controlled oven, accuracy plus or minus ½

degree Centigrade . . . . . \$30.00

This oven accommodates two crystals and is intended for  
amateur stations and some classes of commercial stations.

Temperature controlled ovens, oscillators and crystals for  
commercial use quoted on at your request. Write for description  
and prices.

**PRECISION PIEZO SERVICE**

427 ASIA STREET

BATON ROUGE, LA.

**Amateur Headquarters**

EVERYTHING FOR THE HAM

Famous \$85 National SW-45 Receivers, Special **\$16.50**

5-tube tuned R. F. Uses two 35's, one 27 and two 45's. Coils available from 9 to 2000 meters. Band Spread Coils, \$2.80 pair; Tubes, \$3.25. Use any good 250-Volt pack.

**High Quality Condenser Mike Heads \$11.70**

*See it to appreciate value*

**Parts for Constructing Single Signal Filter, See June QST, Page 25:**

- Hammarlund Selectivity Control Condenser . . . . . \$2.83
- Three-way Selectivity Switch (Yaxley) . . . . . 88c
- Hammarlund Isolantite Phasing Condenser . . . . . 29c
- IRC Grid Coupling Resistor (1-meg.) . . . . . 12c
- Hammarlund Shielded Grid Coupling Choke . . . . . 88c
- Biley Crystal and Holder . . . . . \$6.50

**Complete Kit of the Above Parts \$9.95**

**Build Your Own Monitor \$5.00**  
Complete Kit of Parts,  
Less Tube and Batteries

**M. & H. SPORTING**  
**GOODS CO.**

512 MARKET ST., PHILADELPHIA

**WHERE**

ARE YOUR FIRST SIX ISSUES OF  
THE 1933 SERIES OF

**QST**

**?**

If they are in a QST binder you need read no farther. If not, dollars to doughnuts you won't be able to find them all at the end of the year.

If you want to have and to hold QST use

**QST BINDERS**

**\$1.50 EACH**

POSTPAID

The American Radio Relay League  
West Hartford, Conn.

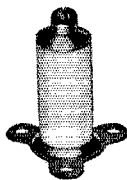

## STAND-OFF INSULATOR

**N**ATIONAL offers another specialized product for the short wave constructor. This little stand-off insulator has glazed Isolantite Insulation, rated at 10,000 Volts, and is equipped with a three-point-mounting metal base to minimize breakage when mounted on unfinished surfaces.

Its low losses and compact size make it particularly suitable for 56 M.C. use, and it will be found very convenient for mounting inductances, chokes, etc., and for supporting High Voltage power leads. Length, overall, 1 1/2 inches. List Price, \$ .25.

Your dealer now has them in stock.

*(Usual Trade Discounts Apply)*

**NATIONAL COMPANY, INC.,  
MALDEN, MASS.**



# SAVE 3 gals. IN TEN

## with CENTRALAB MOTOR RADIO SUPPRESSORS

An automobile distributor reports 11.8 m. p. gal. with his car equipped with ordinary suppressors. The mileage jumped to 15.8 m. p. gal. an increase of 34% with CENTRALAB.

Sell Centralab Suppressors for complete customer satisfaction. Insist upon them for original equipment. Retail price 40c each in all styles.

# Centralab

CENTRAL RADIO LABORATORIES  
DEPT. D MILWAUKEE

an article on five-meter dope. But not any more.

About a month ago the OM was visiting some of the hams in the neighborhood, and he finally wandered into one of those superfone stations. And by super we mean a broadcast station with an amateur license. Now fone had never held any charms for the OM. It was all right for those who couldn't copy code, but give us some real he-man operating. Yes, we will admit we were skeptically inclined toward fone. But, like many another ham, we who had come to scoff remained to talk. After several QSO's that packed more meat than a month of c.w. work, the OM was converted. But — and thereby lies the tale. We looked over the glittering array of equipment, crystal stage to final amplifier, condenser mike to modulator, and taking a sly peek at the family pocket-book, we turned sadly away. Such outfits were only to be thought of in our wildest dreams. So, though the OM was a fone convert, only in the dim distant future could he attempt to realize his dreams.

Sometime later, after a lull in skeds, the OM was idly leafing through some *QST*'s when behold there popped forth from its pages the answer to that fone dream. Why not try five meters? Very little equipment needed — and really good results, or so the pages informed us. Why not have all the fun of fone without having the old homestead sold out by the sheriff? To work, and within a short time there emerged a rather haywire, but workable fone transmitter and receiver. After some discouraging trials the two units were lined up. Five-meter fone was a success! The word spread among the local hams and one by one they dropped in to view the new toy the OM had. After viewing the equipment necessary — or rather the lack of equipment — two new stations appeared. Now the OM is enjoying the rag-chews that he had experienced on the super job. True it was only across town, but what did that matter? The OM's dream had come true, he had a workable fone. C.w. was forgotten, skeds were almost neglected, and five-meter fone became the thing.

Just a wild tale, brother hams, but underlying it far more than may seem apparent. For five meters isn't just a toy, a short-haul job. It's a new field. The edge of its possibilities has only just been scratched. To the ham who is interested in exploring the new, five-meter work presents fascinating appeal. Anything is liable to happen and usually does. When something goes wrong there is very little dope to refer to, and the old think-tank must be used. And we hams could go in for a bit of thinking; we have been letting the other fellow do it too long. Five-meter work may have little miles per watt, but it sure packs more fun per dollar.

— G. A. Rote, *W8DLY*

## Stomach Ache

Springfield, Ohio

Editor, *QST*:

The enclosed report on Standard frequency transmissions is another illustration of the

# PROUD OF IT?

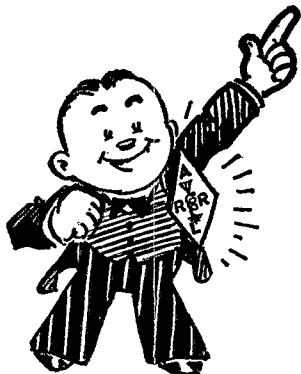

ARE you proud that you are an amateur — proud of your A.R.R.L. membership? Then proclaim it! Let the hams who meet you on the street, in the radio store, or traveling, know it. Wear your A.R.R.L. emblem! The distinctive League emblem comes in three different forms. Its use by members is endorsed and encouraged by the League. Every member should endeavor to display the insignia of his organization in every possible way.

**THE PERSONAL EMBLEM**, in extra-heavy rolled gold and black enamel, just 1/2" high, supplied in lapel button or pin-back style, is recognized as the sign of a good amateur. Wear your emblem, and feel proud of having taken your rightful place in the radio fraternity. Either style, \$1.00, postpaid.

**THE AUTOMOBILE EMBLEM**, heavily enameled in yellow and black on sheet metal, will gain you friends. On the road, traveling, it identifies you as a real amateur. 5 x 2 1/2", holes top and bottom. 50c each, postpaid.

**THE EMBLEM CUT**, a mounted printing electrotype, the same size as the personal emblem, is for use by members on amateur printed matter, letterheads, cards, etc. \$1.00 each, postpaid.

Emblems for Communications Department Officials, 3/8" size, \$1.00 each.

Special red color for the S. C. M. . . . Special green color for the Route Manager. . . . Special blue color for the Official Relay Station appointee.

Note: Red and green colors in pin type only. Blue emblem available both in pin and lapel button types.

*The American Radio Relay League*  
West Hartford, Connecticut

## CONDENSERS FOR EVERY PURPOSE



A complete line of oil and electrolytic transmitting condensers described in our new 1933 Catalog. Sent free on request. Write for your copy now.

**CORNELL-DUBILIER CORP.**  
4377 Bronx Blvd. New York City

## ALUMINUM BOX SHIELDS

Genuine "ALCOA" stock, silvertip finish, 5 x 9 x 6, \$1.65. 10 x 6 x 7, \$2.65. Any Size to Order. SOMETHING NEW! Your call letters, or any marking for your panel, on BLACK aluminum ribbon. Looks like engraving on bakelite. 5c. each, sample, 8c.

Foil for condenser or velocity mike 1/2 mil., 25c. ft. 2 1/4 MH 4 section r.f. choke, 55c. 1/2 watt Neon lamp, 35c. New Master Teleplex on demonstration.

**BLAN, the Radio Man, Inc.** 177 Greenwich St. New York City



## EXTRA!!!

Premier Prices Now within the Reach of All

80 and 160 meter, X or Y cut crystal within 20 kc. of specified frequency. Calibrated in plug-in type holder — COMPLETE WITH HOLDER \$5.00

Crystal — Mounted in plug-in type, air-gap holder for Single-Signal receiver — 465 kc. to 525 kc. — COMPLETE WITH HOLDER. . . . \$7.50

All calibrations made with a General Radio Frequency Standard — Checked with Bureau of Standards Transmissions and Naval Observatory time signals. All calibrations guaranteed accurate to within .001%

Crystals of all descriptions made to order — Prices upon request  
**PREMIER CRYSTAL LABORATORIES, INC.**  
53 PARK ROW NEW YORK CITY

## Radio Operating Radio Servicing—

Prepare for the new Government Radio Operating license examinations; Radio Operator, Marine and Broadcasting. Also Radio Amateur Telegraph and Telephone. Resident courses. Write for booklet "Opportunities in Radio."



West Side YMCA Trade & Technical Schools  
4 West 63rd Street, New York City

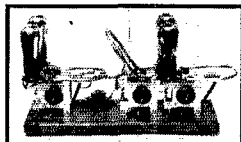

## 56 MC.

Advanced design in 5-meter equipment. A new master oscillator power amplifier transmitter. Oscillator employs two tubes in the highly efficient Unity Coupled circuit. The amplifier is inductively coupled to the oscillator and uses two tubes in push-pull. Tubes may be type '01A, '12A, '45, etc.

Complete oscillator amplifier with power supply plug, mounted on attractively stained baseboard, less tubes, \$16.00.

Oscillator unit only . . . . . \$7.50  
Amplifier unit only . . . . . \$9.50

Trans-receiver as advertised in June QST \$16.50.  
Custom built equipment of all kinds to QST or your own specifications.

**HARVEY RADIO LABORATORIES**  
12 Boylston Street Brookline, Massachusetts

★ ★ ★ ★ Watch the  
**Candler Trained Operators**  
 ★ in the **WORLD'S**  
 ★ **CHAMPIONSHIP**  
 ★ **SPEED CONTEST**

For more than 20 years Candler Trained Radio and Morse operators have led the field in speed and all around telegraphing excellence. What this famous training has done for more than 45,000 of the world's best and fastest operators it will also do for you. It will train your brain, muscles and nerves to coordinate in speed and accuracy. It will give you confidence, natural concentration and will banish all nerve strain. It will make you a master at either end of any kind of transmission, with bug or key and train you to copy 3 to 5 words behind.

Telegraph-Touch-Typewriting — only method for operators. Trains you to use the "mill" in receiving.

Get your speed and accuracy where the champions got theirs. WRITE CANDLER for free advice. If you are a beginner and want to learn code the scientific way, or if you want to become an expert operator, GET THE FACTS and the benefit of Candler's 20 years experience in developing operators. All questions answered personally and promptly. No obligation. Write Now.

**Candler System Co., Dept. 5-B**  
 6343 South Kedzie Ave. Chicago, Illinois

CENTURY of  
 PROGRESS  
 EXPOSITION  
 CHICAGO  
 AUG. 3-4-5

Theodore R. McElroy, winner of Radio Telegraphic Championship of the World three years in a row is Candler Trained.



**WESTON METER BARGAINS**



Model 301



Model 267

- Universal A.C. — D.C. With 5-Position Scale... \$8.40  
 Complete Set Resistors and Shunts... 7.95  
 0-1 Milliammeters (1000 Ohms per Volt)... 5.25  
 0-10 Milliammeters... 5.25  
 0-100 Milliammeters... 5.25  
 0-10, 25, 50 or 100 D.C. Voltmeters... 4.45  
 0-150 Voltmeters D.C... 5.88  
 0-15 A.C. Rect. Type... 6.00  
 0-150 A.C. Rect. Type... 6.50  
 Postage included in above prices
- Milliammeters, 0-10, 0-25, 0-50, 0-100, 0-300, 0-500 \$5.00  
 0-10, 0-15... 5.00  
 Ammeters 0-2, 0-3, 0-7 1/2, 0-10, 0-15... 5.00  
 Voltmeters D.C. 0-15, 0-20, 0-25, 0-50, 0-100, 0-200, \$6.50: 0-500, \$7.40: 0-1000... 8.50  
 A.C. Voltmeters, Rect. Type 0-15 or 0-150... 6.00  
 Milliammeters 0-1 (1000 Ohms per Volt)... 6.00  
 25% deposit with C.O.D. orders

UNIVERSAL WIRELESS SALES CO.,  
 416 N. Leavitt St. Chicago, Illinois

**BLILEY CRYSTALS**  
 POWERFUL ACCURATE UNIFORM

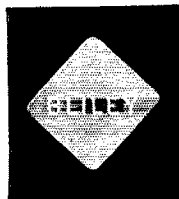

A quality product throughout — 40, 80, 160M. Xcut crystals supplied within 25Kc of specified frequency, \$4.50; 5Kc, \$5.50; 0.5Kc, \$6.50. 20M quartz crystals within 50Kc, \$12.75. Each crystal frequency within 0.05% of calibrated value. SS 465-625Kc mounted filter, \$6.50. 100Kc Std Freq. mounted bar, \$8.50, with instructions. BLILEY Molded Bakelite Holders for modern transmitters. 20-40M, \$1.50; 80-160M, \$1.50. With G-R plus spaced (3/4"), \$2.25. Quartz crystals manufactured to specifications from 20Kc to 15Mc.

Blileys are used by W9USA and on display at  
 WORLD'S FAIR RADIO AMATEUR EXHIBIT  
 BLILEY PIEZO-ELECTRIC CO., ERIE, PA.

thoughtless brass pounding that continually fills the air on all amateur frequencies.

It was not to be expected that the transmission from W9XAN would be heard as the whole evening showed evidence of skip distance, but there was every reason to expect that W6XXK should come in with reasonable volume. All evening stations six hundred miles and more were coming in with loud speaker strength and some of the loudest stations heard were those in the sixth district.

The first transmission from W6XXK on 7000 kc. was satisfactory as there was no other signal near that frequency, but after the shift to 7100 kc. it was just too bad. On that frequency and all of the rest in the band there was no chance for any use of the transmission in this part of the country.

Of course I suppose that it was all done by those hams that never learned to read and so were not able to read in QST just when the transmissions were to be on the air, and such being the case, we will forgive them for this time and hope they all are in bed with the stomach ache when the next transmission is being put on.

— Paul Crowel

**Extending the Freqmeter Calibration**

PAUL E. GRIFFITH, W9DBW, 910-YA, State University of Iowa, at Iowa City, offers a practicable method of getting calibration points beyond the band limits.

"The amateur possessing a frequency-meter of the heterodyne type, calibrated in either the 1.75-mc. or 3.5-mc. band but operating in the 1.75-mc. band, can easily extend its range on both sides of the band for which it is calibrated. All he needs is a receiver which will oscillate in the 14-mc. band and an accurate calibration of his frequency meter.

"To find a point beyond the high-frequency end of the band, first multiply the frequency desired by seven and divide the product by eight. This will give the frequency in the calibrated portion of the band at which to set the meter. Set it there and tune your receiver until you find the eighth harmonic of this frequency, somewhere close to 14 mc. Zero-beat it on the receiver and retune the frequency-meter to the other end of the band until a harmonic beats with the receiver. This will be the seventh harmonic of the frequency and will be the desired frequency that is outside the band on the h.f. end. If it is desired to find a frequency beyond the low-frequency end of the band, multiply the desired frequency by eight and divide the product by seven. This will give a setting of the meter in the high-frequency end of the calibrated portion of the band.

"An example may clear this up: Suppose it is desired to find the meter setting for 2020 kc. Multiply by seven: 7X2020=14140. Divide by eight: this gives 1767.5 kc., the point at which to set the frequency-meter. Zero-beat the harmonic of this and tune the meter past 2000 kc. until the next harmonic beats with the receiver. The point on the meter at which this occurs is the 2020-kc. calibration point.

# HAM-ADS

(1) Advertising shall pertain to radio and shall be of nature of interest to radio amateurs or experimenters in their pursuit of the art.

(2) No display of any character will be accepted, nor can any special typographical arrangement, such as all or part capital letters be used which would tend to make one advertisement stand out from the others.

(3) The Ham-Ad rate is 15¢ per word, except as noted in paragraph (6) below.

(4) Remittance in full must accompany copy. No cash or contract discount or agency commission will be allowed.

(5) Closing date for Ham-Ads is the 25th of the second month preceding publication date.

(6) A special rate of 7¢ per word will apply to advertising which, in our judgment, is obviously non-commercial in nature and is placed and signed by a member of the American Radio Relay League. Thus, advertising of bona fide surplus equipment owned, used and for sale by an individual or apparatus offered for exchange or advertising inquiring for special equipment, if by a member of the American Radio Relay League takes the 7¢ rate. An attempt to deal in apparatus in quantity for profit, even if by an individual, is commercial and takes the 15¢ rate. Provisions of paragraph (1), (2), (4) and (5) apply to all advertising in this column regardless of which rate may apply.

Having made no investigation of the advertisers in the classified columns, the publishers of *QST* are unable to vouch for their integrity or for the grade or character of the products advertised.

OVER six pound radio data, circuits, bulletins, 50¢ postpaid. Beyond Rockies, 75¢. Kladag, Kent, Ohio.

MICROPHONE and meter repairs. Low prices. Quick service. Sound Engineering Corp., 416 N. Leavitt St., Chicago, Ill.

QUARTZ — Direct importers from Brazil of best quality pure quartz suitable for making piezoelectric crystals. Diamond Drill Carbon Co., 719 World Building, New York.

CRYSTALS: \$1.35 Hipower oscillators, close to your specified frequency 3500-1700 kc. bands. Round \$1.60 exact calibration. 7000 kc. band \$4.25. 1" blanks 65¢. Finished blanks 95¢. Dust-proof plug-in holder and mounting, \$1. Set tested mounted I. F. crystals, 525 kc., 465 kc., etc., \$5.25. Grinding compound, course, medium, fine 65¢, each 25¢. Prompt delivery. Hipower Crystal Co., 3607 N. Luna Ave., Chicago, Ill.

CRYSTALS, guaranteed. 1750 to 4000 kc. 1" within 5 kc., \$2.50. ¾ to 1", within 10 kc., \$2. 7000 to 7300 kc. within 20 kc., \$3.50. Wm. Threm, W8FN, 4021 Davis Ave., Cheviot, Ohio.

QSLs — 85¢. Free samples. W8AKY.

THIS month only — guaranteed crystals, \$1.25. W4VK, Ripley, Tenn.

SPREADERS. Hard rubber, 8", \$1.50 dozen. W8BSR.

CRYSTALS: 1", approximate frequency, prompt service. Guaranteed, \$1.35. W9HWE.

LIKE finding \$1,000.00. Relay racks. Station equipment. See April display. Rectifier Engineering Service.

TWO color QSLs, 50 and 75 cents. W9GOF, Mishawaka, Ind.

TRANSMITTING and receiving equipment manufactured to order. Holmes C. Miller, Radio Engineer, Box 105, Palo Alto, California.

203As brand new, Westinghouse or GE, \$10.00. 203A class B transformers \$8.50. Counterbalanced Cardwell 166Bs — \$20.00. Heavy duty 866s — \$2.50. 872s — \$7.50. New RCA Ux 250s — \$1.75. Weston type 301 milliammeters (some new, all new condition, most all ranges) \$3.75. 204As — \$20.00. 212Ds — \$16.00. Instructographs, etc. List. Want 1kw AC generator, 849s. Bwing, 1057 Pratt Blvd., Chicago.

1000 volt mfd. condensers. Ideal for 210 filters, 20¢ each. 10 for \$1.50. Double chokes 30H 150 MA each section \$1.50. Thordarson 210 power transformers, 1300V a.c. 175 MA. 2-7 ¼ V windings, \$4.50. M. Apstein 100-5th Ave., New York City.

ALUMINUM chassis, 8/10¢ sq. in., custom built receivers. W2BUF, 226 Sterling St., Orange, N. J.

BARGAINS — Vibroplex \$10. Pair REL type S inductances. \$5. Philco 12 watt demonstration dynamic \$7. Western Electric key, \$2. five tube shielded T.R.F. — SW a.c. receiver band spread coils and tubes, \$12. ½ hp. General Electric motor 110 or 220 volt a.c. \$13. All items new or new condition and guaranteed. List. Wanted — National plug-in coils all sizes. W3KA, 429 Cuyler Ave., Trenton, N. J.

40 meter crystals to swap, also 242As, meters, filter crystals, etc. W9DOQ, Route 1, Duluth, Minn.

FOR sale — used — Universal 250 watt s.g. tube with socket, \$16. Driver lathe, planer, ex-shafting, hangers, complete \$10. Weston 0.7V d.c. \$1.25. Thordarson 30H 300 mil. choke, \$5. New. 865, \$5., National 2SE100, \$3. Hammarlund 2 mc. 140, \$1.50. Want — small water-cooled tube, 500 mil. choke. H. Southwick, County St., R. 1., Somerset, Mass.

WANTED: complex dx phone transmitter or transmitting apparatus, also SW receiver — National a.c. SW5, preferred. What have you? Cash for bargains. W9GLR, 218 20th St., S. E., Mason City, Iowa.

TELEPLEX, four tapes, code practice set. All \$10. E. E. Pack, Hinton, W. V.

SELL National NC-5 converter splendid condition. Make offer. Harry C. Hicks, 2471 University Ave., New York.

QSL cards! Free samples. 'Nuff sed! W8DED, Holland, Mich.

PYREX lead-in bowls, dollar, pair. (four bowls). Postpaid. W9CKB, Ft. Wayne.

WILL pay one dollar each for following copies of *QST*. January, February, March, April, June, July, August, September, November, December of 1916. September of 1917. August, September, October, November of 1919. February of 1922. W6VQ.

SELL 150 watt transmitter. Finest parts. Send for list. W2JY.

REBUILT microphones — good as new — many makes and types, at bargain prices. Write to-day for list. Also catalog of new microphones. Expert microphone repairs. Shure Brothers Co., 337 W. Madison St., Chicago.

QSL cards, two color, cartoons, message blanks, stationery, snappy service. Write for free samples to-day. W1BEF, 16 Stockbridge Ave., Lowell, Mass.

QSL cards, neat, attractive. Reasonably priced. Samples free. Miller, Printer, Ambler, Pa.

SELL: 75 watt controlled transmitter, complete with tubes, crystals, power supply. W8DRP, 1975 Taylor Rd., East Cleveland, Ohio.

CONDENSERS — Real he-man jobs. Heavy steel cased. All voltages working potentials. Tested 50% overload. Compare! 2 mfd. 2000 volt, \$3.95; 3000 volt, \$6.95; 4000 volt, \$9.95. Guaranteed. J. S. Huffman, W5AUB, Tupelo, Mississippi.

QSLs by Maleco. Finest in country. Free samples. Maleco, 1512 Eastern Parkway, Brooklyn, N. Y.

TWO Westinghouse meters, 50V, 30-0-30 amp. in battery charging panel, fuses, switch, connectors, resistance, in metal case, \$2.75. E. C. Williams, 5710 Harvard St., Pittsburgh, Pa.

CODE machines, tapes and complete instructions for beginners or advanced students — both codes — for sale or rent reasonable. Rental may apply on purchase price. Extra tapes for all machines. Instructograph, 912 Lakeside Place, Chicago.

ENGRAVING — in bakelite or cracked aluminum. Panels made to order. Arrow, 560 Washington, Chicago.

FILTER chokes — heavy duty, steel cased, 15 henry 200 mils. \$1.85. Others made to order. Ruland's, Natick, Mass.

WANTED — National SW3, a.c. W. Manning, Gloversville, N. Y.

TRADE or sell: ¼ hp. 110V, 25 cycle G. E. motor, Albert clarinet. Want xmitter parts. W9BTF.

TELEPLEXES, Omnigraphs, Vibroplexes, receivers, all short wave goods, bought, sold, exchanged. Ryan Radio Co., Hannibal, Mo.

COMPLETE xtal controlled portable, \$35. Stamp brings info. W9DKF, Peoria, Ill.

SELL converter \$6. RCA course, \$6, tapes \$10. W8DNV.

CRYSTALS, x or y cut finished quartz, 1750 kc. to 4000 kc. C.O.D. \$2. Scheuffer Radio Service, Sandusky, Ohio.

RCA 851 used 100 hours, \$55. Brand new 212D, \$15. W3CGA.

QSLs, 75¢ a 100, two colors. W9DGH, 1816-5th Ave., N., Minneapolis, Minn.

XTAL blanks, 50¢ each. W9DGH.

QSLs — W6DOU, 1562 "B" St., Hayward, Calif.

QSLs, 50¢ per 100. Samples. 2143 Indiana Ave., Columbus, Ohio.

VIBROPLEXES, \$12 up. Rebuilds \$6 to \$10. Guaranteed. Lydeard, 28 Circuit, Roxbury, Mass.

QSLs, 200, \$1. New samples. Foster Press, Appleton, Wis.

HEY! Fellas! Shine up those Dials and engraved Panels, bring out those dirty numerals and Engravings, make them white again. Postpaid in U.S. one large stick white Engraving Wax and Bottle of Polish with Instructions for Twenty-Five Cents in Coin. W8AXB, 3411 Harrison Ave., Cheviot, Ohio.

METERS repaired accurately at reasonable rates. Electrical Instrument Labs., 1542 Hertel Ave., Buffalo, N. Y.

TRANSFORMERS, reactors made to order. Accurate, dependable. Special summer prices — buy now. Baker Engineering Laboratories, Ft. Wayne, Indiana.

VOLOVOX Dynamic Microphones. Broadcast quality. With coupling transformer, \$9.75 postpaid in U.S. — Baker Engineering Laboratories, Ft. Wayne, Indiana.

QSLs, 200 two colors, \$1. Ham Print, R5, Box 278, Phoenix, Ariz.

TRADE Philco short wave converter for short-wave receiver. C. L. Shauers, Del Rio, Tex.

QSLs, 100 — 50¢; .001" dural, 32 square inches, 20¢; 8 Henry 300 mil. first choke, cased \$1.25. W8CPE, Springdale, Penna.

FB-7s \$26.46, FB-Xs \$38.22, coils, \$5.88; SW3s \$14.40, coils \$2.79; Comet Pros; Guaranteed \$665 \$1.95; any apparatus. Sell, trade used apparatus too. Henry's Radio Shop, Butler, Mo.

212Ds, \$18, RCA 204As, \$25. Guaranteed perfect condition. W9ARA.

CLASS B transformers — for 46s, \$4.95 pair. Universal transformers for 2 or 4 46s, 210s, etc. \$7.75 pair. Write for details. W8UD, Douglas, Mich.

COMPLETE electron-coupled (a.c.-d.c.) calibrated monitor frequency meter, \$13.50. With a.c. power supply, \$18.95. QST autodyne receiver, \$19.95. Beginners crystal transmitter, \$20. Five meter receiver, \$12. Transmitter, \$7. Write for catalog. We build to order. Precision Radio Labs., 109 E. 94 St., Brooklyn, N. Y.

GUARANTEED 212D — used 50 hours. Will trade it and socket for two 852s or 203As. W5AUW.

LARGE stock new and used Silver-Marshall, Samson "Pam" and Western Electric sound equipment, bargains. Wells-Smith Corp., 24 N. Wells, Chicago.

CRYSTALS: Guaranteed excellent oscillators, your approximate frequency, 160 or 80 meters \$1.35 postpaid. "Crystal Maker's" blanks 1" 65¢ — dozen \$6.00, 3/4" 50¢ — dozen \$4.80. Irregular shapes 25¢. Standard dust-proof plug-in Holders 75¢. Pure Brazilian quartz \$1.50. lb. and up. Fisher Laboratory, 1200 E. Nevada, El Paso, Texas.

QSLs, SWLs, wall cards. Satisfaction guaranteed. W3BHG, 3536 Roland Ave., Baltimore.

CRYSTALS: Close to frequency, \$2.01; exact, \$2.51. Accuracy 0.05%. Oscillating single signal filters, \$2.51. All unconditionally guaranteed. Postpaid. Smith-Precision — W6BCX.

CLASS "B" transformers for 46s, \$4.25; 210s, \$5.25. Ruland's, Natick, Mass.

CRYSTAL Transmitter, 3-stage UX210, two power units \$32.00. TNT Transmitter, \$5.00. Receiver, \$4.00. Extra heavy 550-750 volt power unit, with 866's \$12.50. Meters, other parts bargains. Hal Justice, Canton, North Carolina.

WIRELESS code classes in New York for beginners and advanced. Complete training amateur license, \$1. Weekly. Hart, 3407 Washington Ave., Astoria, L. I.

GENERAL Electric 24/1500 volt 350 watt dynamotor, brand new, \$20. General Electric 2 kw. pole transformer 1100-4400 volts output, \$10. H. C. Wing, Greenfield, Mass.

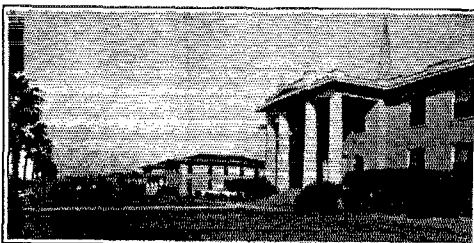

In 3 to 7 months we train you to secure government license. Course consists of Wireless Code, Radiophone, Microphone-Studio Technique, Television, Service, Police, and Aeronautical Radio. We are authorized to teach RCA Institutes, Inc., texts. Return coupon for details.

Name .....  
Street or Box .....  
City and State .....

**PORT ARTHUR COLLEGE**  
PORT ARTHUR, TEXAS

## QST OSCILLATING CRYSTALS

"Superior by Comparison"

### WHY YOU SHOULD USE SCIENTIFIC RADIO SERVICE CRYSTALS

- 1 Since 1925, we have been specializing in producing Piezo Electric Crystals exclusively.
- 2 Since 1925, Scientific Radio Service Crystals have stood the test and are recognized the world over for their Dependability, Output and Accuracy of Frequency.
- 3 Since 1925, owners of Broadcast and Commercial Short Wave stations have found that no chances can be taken in getting the cheaper grade of crystals and that invariably they call on Scientific Radio Service for the Best.
- 4 Since 1925, we could be depended upon to make Prompt Shipments. This coupled with a crystal Second to None considering Output and Accuracy of Frequency has earned during these years a reputation which we jealously guard. Therefore, Get the Best.

Price list sent upon request

### SCIENTIFIC RADIO SERVICE

"The Crystal Specialists"

124 JACKSON AVENUE, UNIVERSITY PARK  
HYATTSVILLE, MARYLAND

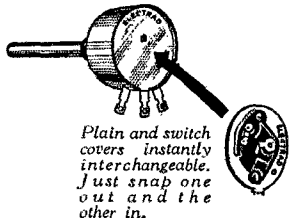

Plain and switch covers instantly interchangeable. Just snap one out and the other in.

### Only Five Types Fit 799 Models of Receivers

**T**HE handiest volume control that ever graced a receiver.

Power-switch assembly may be instantly installed, if desired, without disturbing control connections.

Long ALUMINUM shafts, too. Easily cut to any required length. Saves time and temper.

Write Dept. Q-7  
for Complete Catalog

175 Varick St., New York, N.Y.  
**ELECTRAD**

# Your Nearest Dealer Is Your Best Friend

Your nearest dealer is entitled to your patronage. You can trust him. He is equipped with a knowledge and understanding of amateur radio. He is your logical and safe source of advice and counsel on what equipment you should buy. His stock is complete. He can supply your needs without delay. His prices are fair and consistent with the high quality of the goods he carries. He is responsible to you and interested in you.

Patronize the dealer nearest you—You can have confidence in him

<b>CHICAGO, ILLINOIS</b> Chicago Radio Apparatus Company 415 South Dearborn Street Dependable Radio Equipment      Established 1921	<b>PHILADELPHIA, PENNSYLVANIA</b> Eugene G. Wile 10 S. Tenth Street Complete Stock of Quality Merchandise
<b>CHICAGO, ILLINOIS</b> Mid-West Radio Mart 520 S. State Street All standard lines carried in stock	<b>PITTSBURGH, PENNSYLVANIA</b> Cameradio Company 603 Grant Street Tri-State "Ham" Headquarters Standard Apparatus      Standard Discounts
<b>CLEVELAND, OHIO</b> Northern Ohio Laboratories 2073 West 85 Street W8BAH serving Cleveland and greater Cleveland Hams.	<b>PROVIDENCE, RHODE ISLAND</b> W. H. Edwards & Company 32 Broadway, Room 23 A full line of reliable Amateur Equipment & Supplies
<b>CLEVELAND, OHIO</b> Radio Servicemen's Supply Co. 206 Prospect Street Wholesale Distributors catering to Amateurs, Dealers, Servicemen	<b>ST. LOUIS, MISSOURI</b> Walter Ashe Radio Company 1100 Pine Street W9FIS in charge of the oldest and largest parts store in St. Louis
<b>DENVER, COLORADO</b> Vreeland Radio Corporation 1639 Tremont Street Amateur Radio Headquarters in the Rocky Mountain Region	<b>ST. PAUL, MINNESOTA</b> Lew Bonn Company 2484 University Avenue Rex L. Munger, W9LIP, Sales Engineer Radio Wholesaler      Complete Stock
<b>DETROIT, MICHIGAN</b> Radio Specialties Company 171 E. Jefferson Avenue Ham Supplies — National & Hammarlund Sets and Parts	<b>SAN FRANCISCO, CALIFORNIA</b> Offenbach Electric Company, Ltd. 1452 Market Street "The House of a Million Radio Parts"
<b>HARTFORD, CONNECTICUT</b> Radio Inspection Service Company 227 Asylum Street Complete line of guaranteed parts	<b>SCRANTON, PENNSYLVANIA</b> Radio Service & Supply Company 608 Linden Street The only "Ham" Supply Store in N. E. Pennsylvania
<b>KANSAS CITY, MISSOURI</b> Burstein-Applebee Company 1012-14 McGee Street "Specialists" in supplies for the Amateur and Serviceman	<b>SPRINGFIELD, MASSACHUSETTS</b> T. F. Cushing 345 Worthington Street An amateur, endeavoring to sell good parts
<b>KANSAS CITY, MISSOURI</b> Radio Laboratories 1511 Walnut Amateur Headquarters — Complete Stock — Quality Parts	<b>SYRACUSE, NEW YORK</b> Roy C. Stage, W8IGF Complete stock of standard Ham & BCL parts Standard Discounts. Free technical service by W8AOW
<b>MILWAUKEE, WISCONSIN</b> Radio Parts Company, Inc. 332 West State Street Complete stock Nationally Known products	<b>UTICA, NEW YORK</b> Vaeth Electric Company 701 Varick Street Wholesale Distributors of Radio Parts and Supplies
<b>NEWARK, NEW JERSEY</b> Kaltman & Romander 62 Court Street Drop in for an over-counter QSO	
<b>NEW ORLEANS, LOUISIANA</b> Rose for Radio 129 Camp Street Complete stock quality radio parts	

This advertisement is paid for by the firms listed above. Qualified dealers are invited to apply for rates, etc., to Advertising Department, QST

Say You Saw It in QST — It Identifies You and Helps QST

# You Are Protected When You Buy From QST Advertisers

¶ "Advertising for QST is accepted only from firms who, in the publisher's opinion, are of established integrity and whose products secure the approval of the technical staff of the American Radio Relay League."

Quoted from QST's advertising rate card.

Every conceivable need of a radio amateur can be supplied by the advertisers in QST. And you will know the product has the approval of the League's technical staff.

● See Editorial April issue of QST

## For Your Convenience QST'S INDEX OF ADVERTISERS IN THIS ISSUE

Allen-Bradley Company .....	80
A.R.R.L. Application Blank .....	64
A.R.R.L. Booklets .....	69, Cov. II
A.R.R.L. Emblem .....	73
A.R.R.L. Handbook .....	66
A.R.R.L. Special Offer .....	Cov. IV
A.R.R.L. Supplies .....	67
Blan, The Radio Man, Inc. ....	73
Bliley Piezo-Electric Co. ....	74
Candler System Company .....	74
Capitol Radio Engineering Institute .....	69
Cardwell Mfg. Corp., Allen D. ....	1
Central Radio Laboratories .....	72
Chicago Radio Apparatus Co. ....	70
Cornell Elec. Mfg. Co. ....	73
Electrad, Inc. ....	76
Gross Radio Company .....	65
Gulf Radio School .....	68
Hammarlund Mfg. Company .....	4
Harvey Radio Labs. ....	73
Hatry & Young .....	69
Kaltman & Romander .....	71
Leeds .....	79
Littelfuse Labs. ....	69
M & H Sporting Goods Co. ....	71
National Company .....	63, 72, Cov. III
Port Arthur College .....	76
Precision Piezo Service .....	71
Premier Crystal Lab. ....	73
QST Binder .....	71
Radio Supply Company .....	70
RCA Institutes, Inc. ....	70
Scientific Radio Service .....	76
Silver, Inc., McMurdo .....	68
Sound Engineering Corp. ....	70
Teleplex Company .....	68
United Radio Mfg. Co. ....	69
Universal Microphone Co. ....	69
Universal Wireless Sales Co. ....	74
Westinghouse Elec. & Mfg. Co. ....	73
West Side Y.M.C.A. ....	2



# SUMMERTIME BRINGS STATIC!

LEEDS Appropriately Announces The **OPENING** of A "SALON" To Keep It In!

Our "Static Room" now open for greater service to amateurs. Out of town hams use "Leeds Static Room" as your New York mailing address. A ham fest is in progress daily from nine to five. It's your room; come in and use it, gang. You can expect the QRM to be QSA-5 R Nertz.

It's the season for 5 & 10 too. The New NATIONAL SRR is ideal for use at home and afield for these bands. It can also be used as a regenerative receiver on the other amateur bands. The 5 meter, 3 tube set, uses a 36 screen grid reg. detector, a 37 interruption frequency oscillator and an 89 pentode audio amplifier tube. The receiver requires 6 volt A supply and a 135 v. B supply. Either B batteries or A.C. operated power pack suitable. The National 5886 A.B. power pack will supply both A & B voltages. Set complete less tubes. **\$14.70** List \$25. *Special.*

10-20-40 meter coils ea. **44c**  
80-160 meter coils ea. **\$1.03**

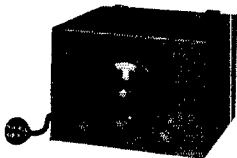

And the NATIONAL FBX is the answer to static reduction on the low frequency bands. The crystal filter will reduce the static band at least **70%**.

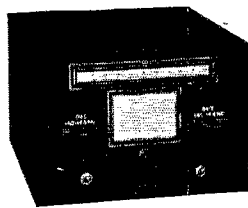

FBX Crystal filter model. **\$38.22**  
FBX-A with air tuned I.F. **\$42.93**  
All coil ranges, each. **5.88**  
5887 AB Power supply **\$14.42**  
5897 AB Power supply **\$20.29**

## NATIONAL SW 3

The Popular SW 3 receivers now available in three models—with 2 volt, 2½ volt and 6 volt tubes. **\$14.42**

Prices reduced to.....  
for the receiver and only **\$2.79** for each range of band-spread coils.

## WESTERN ELECTRIC

Signal Corps Type P-11 head phones; never sold below \$7.60 a pair. Now at a typical LEEDS bargain price, **\$3.95** per pair, of only.....

### Genuine Type C Baldwin Phones

**\$12.00** List—Mica diaphragm. Limited quantity—only 2 pair to a **\$3.75** customer. *Special.*

## NEW JOHNSON INSULATORS FOR EVERY PURPOSE

Micromite standoff insulators only ½" high; each..... **5c**

Midget standoff 1½" high; each..... **8c**

Midget standoff 1½" high with top hole large enough to fit General Radio 274 jacks. Ideal for plug-in coils for low power transmitters; less jack, each only **10c**; G.R. jacks for same, each..... **5c**

Feeder separators of wet processed glazed porcelain 6" long; each..... **15c**

Antenna insulators the same finish 7" long 1" dia. **40c-12"-50c-18"-70c**

## JEWELL 2" METERS

A few still left as advertised last month. Write us for the one you are interested in — if we still have it we'll hold it for you.

We can supply Crystal Filters illustrated in June *QST* for Hammarlund **\$16.00** "Pros." Filter unit complete

Parts necessary to make beat oscillator a "front panel" control **\$1.50**

And we keep right on selling those low priced Grammer kits. More QRM perhaps, but we are glad it is of the T-9 Crystal variety.

Oscillator doubler..... **\$12.75**

Amplifier kit..... **\$7.50**

Power supply kit..... **\$5.70**

G.F. 50 Watt Socket — bakelite base; double phosphor bronze contacts **69c**

LEEDS 50 Watt Socket — porcelain base; double phosphor bronze contacts **95c**

Leeds 866 trans. — 2½ v. 10 amp. Center tapped, 10,000 v. insulation..... **\$2.75**

Leeds mtd. fil. trans. 7½ v. 5 A.C.T. **\$2.95**

Leeds mtd. 10 v. 7 amp. fil. trans. 3 prim. line taps to insure correct v..... **\$3.95**

Leeds mounted fil. trans. 2½ v. 10 amp. 1000 v. insulation for receiver or 888 fil. in low voltage power supplies. **\$1.15**

Leeds single button Mike trans.... **1.25**

Leeds double button Mike trans.... **1.45**

### NATIONAL

R 152 new type Chokes..... **\$1.32**

R 100 new type Chokes..... **.44** fully described on page 66 May issue.

There are a number of brand new **CARDWELL** transmitting condensers available at new low prices. Bulletin will be sent on request.

## DEFORREST

503-A 511 and 545 tubes, now manufactured under R.C.A. supervision; each..... **\$15**

## New Low Crystal Prices

Y cut crystals 160-80 M. bands .1 of 1% accuracy..... **\$3.50**

Y cut 160-80 M. oscillator blanks..... **2.00**

X cut 80 M. .1 of 1% accuracy..... **4.75**

X cut 40 meter Crystals, random frequency, **\$6.50**

Leeds dustproof holder..... **1.45**

DeLuxe model..... **1.89**

General Radio crystal holder..... **2.25**

## KENYON

Remember there are Kenyon transformers and chokes to fill every amateur and broadcast requirement. We carry a complete line of this equipment and will be glad to furnish bulletins and our lowest wholesale prices on request.

Kenyon uncased class "B" Transformers. Minimum space requirements — light weight — good quality — lowest prices.

2½ v. C.T. 6 amp

5 v. C.T. 3 amp

6.3 v. C.T. 2½ amp

7½ v. C.T. 3 amp

Class "B" input transformers for 46's — 49's — 53's — 59's — 79's — 89's, each **\$1.43**

Output transformers to 4000 ohm R.F. load for these tubes, each..... **\$1.86**

Output transformers to voice coil..... **1.71**

**95c each**

## Collins Transmitters

Another popular line added to our stock. Write us for information and bulletin.

We do not publish a catalog. Lowest current prices quoted by return mail on all short wave apparatus. Hundreds of other items at Special Prices.



45 Vesey Street, New York City  
New York Headquarters for Transmitting Apparatus

FEDERAL F108-A, 175 watt oscillator R.F. amplifier tubes.. **\$34.50**

Mail Orders Filled Same Day  
C. O. D. Orders Must Be Accompanied by 10% Deposit

# A.C. RELAYS

Made by

## Allen-Bradley

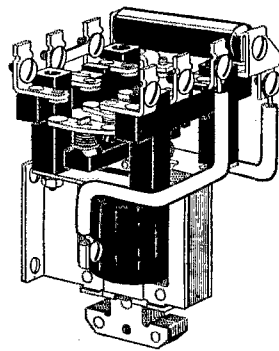
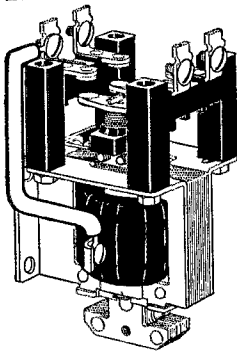

These A. C. solenoid relays are ideal for remote control of transmitters, for control of crystal ovens, and for any general remote control application except for keying. **THESE RELAYS WILL NOT OPERATE IN KEYING SERVICE.** Silver-to-silver double break contacts are used throughout.

The maximum contact rating is 10 amperes at 220 volts. The relay coils are wound for 115 volts 60 cycle alternating current. Relays for other voltages can be supplied on special order. Use coupon below when ordering.

Type No.	Poles	Nor- mally	Circuit Diagram	Price		Type No.	Poles	Nor- mally	Circuit Diagram	Price	
				Open	In Cab.					Open	In Cab.
A107	1	Open		\$3.00	\$4.00	A177	1	Closed		\$5.00	\$6.00
A117	1	Closed		3.00	4.00	A207	2	Open		3.50	4.50
A127	1	Open and Closed		3.50	4.50	A217	2	Closed		3.50	4.50
A137	1	Open		3.50	4.50	A227	2	Open and Closed		4.50	5.50
A147	1	Closed		3.50	4.50	A237	2	Open		4.00	5.00
A157	1	Open and Closed		4.00	5.00	A247	2	Closed		4.00	5.00
A167	1	Open		5.00	6.00			 <p><b>Radiostat</b>—A stepless graphite compression rheostat for primary of 550 watt filament or plate supply transformer. Range 4 to 150 ohms. <b>Price \$6.50</b></p>			

### ORDER BLANK—MAIL WITH REMITTANCE TO

Allen-Bradley Co., 108 W. Greenfield Ave., Milwaukee, Wis.

Enclosed find money order for \$..... for which please send me, shipping charges prepaid, the following items:

Name .....

Address .....

# "THE QUALITY GROUP"

AGS & AGSX

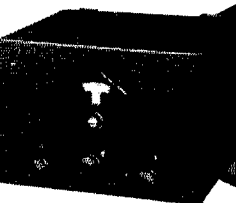
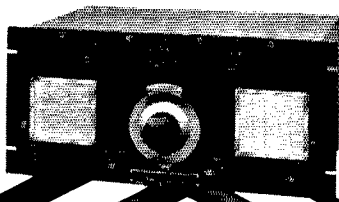

SRR & SW-3

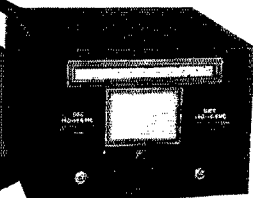

FB-7 & FB-X

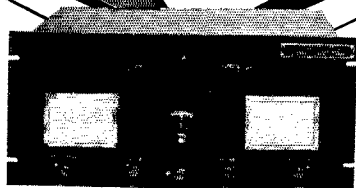

AGU & AGL



AGS and AGSX Superlative Communications Type Short Wave Superheterodynes for Relay Rack mounting. Both employ 9 tubes with T.R.F. preamplification and preselection, c.w. oscillator, automatic volume control and, in addition, the AGSX provides Single-Signal (Lamb type mechanical quartz filter) operation.



AGU and AGL. Two new National Receivers: the AGU similar to the AGS electrically, but having the three plug-in coils assembled in a single unit for ease of handling, and the AGL for long-wave use with a Frequency Selector Switch substituted for the plug-in coils.



FB-7 and FB-X. Designed specifically for the advanced amateur, the FB-7, a modern superheterodyne, and the FB-X, a Single Signal (Lamb type mechanical quartz filter) receiver, provide extreme flexibility and compactness with outstanding performance. Air tuned i.f. optional.



SRR. A super-regenerative 5-meter receiver offering simplicity to the beginner and versatility to the experimenter. Coils are available for all of the amateur bands. Extremely compact.



SW-3. A general purpose short-wave set reduced to its simplest form. This, the most widely used of all amateur receivers, employs three tubes — tuned r.f., regenerative detector and impedance coupled audio.

Complete information on any of the above will be mailed on request.

**NATIONAL COMPANY, INC., MALDEN, MASS.**

